



PROGRESS. POWERED BY YOU.



2022

INTERNATIONAL CATALOG
MILLERWELDS.COM



Miller®

The Power of Blue®



MILLER® PRODUCTS.

BUILT BY PEOPLE LIKE YOU, FOR PEOPLE LIKE YOU.

Careful planning. Attention to detail. Pride in a job well done. That's how people like you weld. That's how people at Miller work.

For more than 90 years, dedicated Miller employees in Appleton, Wisconsin, have put expertise, ingenuity and work ethic into everything we build. And because we listen to the people who use our equipment, we're always creating new solutions to meet your needs.

Whether you weld to build a project, a business or a dream, you can depend on Miller products to get the job done right. Because we work the way you work.



MillerWelds.com



NEW FROM BLUE

9 Millermatic® 355



89 Face Shield P APR



93 Cut-Resistant Welding Gloves



96 MobileArc™ Augmented Reality Welding System



MILLER DISTRIBUTORS. KNOWLEDGE. ADVICE. SUPPORT.

When you work with a Miller distributor, you're working with a valued partner. You can depend on their in-depth knowledge and assistance to select a perfect Miller solution — and their support throughout your product's long lifetime of service. Visit MillerWelds.com to find a Miller distributor near you.



BENEFITS OF BLUE. TECHNOLOGIES AND INNOVATIONS.

Miller is committed to bringing forward-thinking technologies and solutions to the welding industry. We listen to your challenges and constantly seek to improve our products and services to better address them.

EASE OF USE

ArcConnect™

Next generation communication that utilizes high-speed signals to improve weld performance and allow point-of-use controls to be located at the feeder. Found on the Deltaweld® Systems.

AUTO-LINE™ TECHNOLOGY Allows for any input voltage hookup with no manual linking. Provides convenience in any job setting and is ideal for dirty or unreliable power. Found on the following products:

MIG

Millermatic® 255
AlumaPower™ 350
Invision™ 352
Continuum™
Auto-Continuum™

Multiprocess

Multimatic® 255
Maxstar®
Dynasty®
XMT® 350

Stick

Maxstar®
CST™ 282

TIG

Maxstar®
Syncrowave® 210
Dynasty®

Plasma cutters

Spectrum®

AutoSense™

Reduces issues related to setting helmet sensitivity by allowing welder to push and hold the AutoSense button to automatically set the helmet sensitivity for their environment. Found on Digital Infinity™ and Digital Elite™ welding helmets.

Auto-Set™

Provides speed, convenience and confidence of preset controls and eliminates guesswork when setting weld parameters. Variations of this technology include **Advanced Auto-Set** and **Auto-Set Elite**. Found on the following products:

MIG

Millermatic® (except 252)

Multiprocess

Multimatic®

TIG

Syncrowave® 210

MVP™ plugs and adapters

Allows connection to common 120- or 240-volt receptacles without the use of tools — just choose the plug/adaptor that fits the receptacle. Found on the following products:

MIG

Millermatic® 211

Multiprocess

Multimatic® 200/215
Multimatic® 220 AC/DC

Stick

Thunderbolt® 160

TIG

Diversion™
Syncrowave® 210

Engine drives

Fusion

Plasma cutters

Spectrum® 375/625



Provides single-phase stick weld capability with the engine shut off by plugging into 120- or 240-volt wall power. Ideal for indoor or noise-sensitive environments. Found on the Fusion engine drive.

Pro-Set™

Provides speed, convenience and confidence of preset controls and eliminates guesswork when setting TIG or stick weld parameters. Found on the following products:

Multiprocess

Multimatic® 220 AC/DC
Multimatic® 235
Maxstar®
Dynasty®

TIG

Syncrowave®
Maxstar® (except 161)
Dynasty®

QuickTech™

Provides easy setup and process changing on the Multimatic® 220 AC/DC multiprocess welder.

- *Automatically* determines polarity. Work is always connected to the bottom right receptacle. MIG gun and TIG torch can stay connected at the same time.
- *Automatically* switches to the right process. Just hit trigger or foot control and the machine automatically changes, eliminating the need to manually change processes.
- *Automatically* recalls settings from the last process used.

Remote start/stop

Allows you to easily turn your Bobcat™ welder/generator on and off remotely so it only runs when you need it. Get more out of each tank, extend time between maintenance and work without the hassle of walking back to your machine. Found on the Bobcat™ 225 and 260 (non-LP) engine drives.



X-Mode™

Electromagnetically senses the weld to reduce sunlight interference and continuously detects the arc even if sensors are blocked. Found on the T94™, Digital Infinity™, Digital Elite™ and Classic VSi™ welding helmets.



OPTIMIZATION AND PERFORMANCE

Advanced welding processes

Versa-Pulse™ is a fast, low-heat, low-spatter process designed for materials up to 6.4 mm (1/4 in.) and is great for gap filling.

Accu-Pulse® is better for out-of-position welds, provides higher deposition rates and has the most adaptive arc on 16 gauge and thicker materials.

RMD® (Regulated Metal Deposition) is a modified-short-circuit process with the lowest heat and limited travel speed.

Designed to fill gaps in thin-material applications, it provides a higher quality root pass, a calm stable arc and less spatter.

Advanced welding processes are found on the following products:

MIG

Deltaweld® 350/500 with Intellx™ Pro feeder (Accu-Pulse only)
Continuum™ Systems
Auto-Continuum™ Systems

Multiprocess (RMD only)

XMT® 350 FieldPro models with ArcReach Smart Feeder
PipeWorx 400 System

Engine drives (RMD only)

Trailblazer® 325 ArcReach models with ArcReach Smart Feeder
Big Blue® ArcReach models with ArcReach Smart Feeder

Augmented reality welding

Training solution that builds a larger, more skilled welding workforce and quickly helps correct errors, reinforces proper welding practices and accelerates skill advancement. Found on the MobileArc™ and AugmentedArc™ augmented reality welding systems.

ClearLight™ Lens Technology

Provides high-definition optics for precision arc recognition. Found on T94™, Digital Infinity™, Digital Elite™, Digital Performance™ and Classic Series welding helmets.

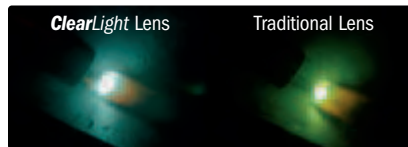

DYNAMIC DIG™

Automatically adjusts the amount of current required to clear a short. Delivers a smoother, more consistent arc that can be tailored to match the application, material, fit-up and welder technique. Found on Trailblazer® 325 and Big Blue® engine drives.

Insight™ Welding Intelligence™

Insight Core™ is an easy-to-use welding information solution that gives visibility into your operation so you can improve productivity.

Insight Centerpoint™ is a real-time welder feedback solution that provides guidance and control within the weld cell to ensure consistent weld quality.

Insight Welding Intelligence is found on the following products:

MIG (Insight Core standard)

Deltaweld® 350/500
Continuum™
Auto-Continuum™

MIG (Insight Centerpoint optional)

Continuum™
Auto-Continuum™

Note: Insight Core is compatible with many 14-pin compliant Miller® power sources (see chart at MillerWelds.com/insight) using an Insight Core 14-pin module or ALL power sources using an ArcAgent for Insight Core. Insight Centerpoint is compatible with ALL power sources using an ArcAgent Manual or ArcAgent Auto.

PRODUCTIVITY

ArcReach® Allows operators to adjust welding parameters right at the weld joint without a control cord, using the wire feeder or remote — maximizing arc-on time and impacting the bottom line.

Found on the following products:

Multiprocess

XMT® 350 FieldPro™ models
XMT® 450 CC/CV ArcReach
Dimension™ 650 ArcReach

Engine drives

Trailblazer® 325 ArcReach models
Big Blue® ArcReach models

Auto-Speed™

Automatically adjusts engine speed to meet demands so the engine never works harder than necessary. Reduces fuel consumption and noise levels on the Bobcat™ 200 Air Pak™ and Trailblazer® 325 engine drives.

Excel™ power

Provides 2,400 watts (20 A) of 120-volt power at all engine speeds, including idle. Reduces fuel consumption and noise levels on select models of the Trailblazer® 325 engine drive.

Fan-On-Demand™

Fan only operates when needed to reduce noise, energy use and amount of contaminants pulled through the machine. Found on various MIG, multiprocess, stick, TIG and plasma cutter products.

InfoTrack™

Data monitoring technology tracks arc time and features a clock. Version 2.0 adds arc count. Found on the T94™ and Digital Infinity™ welding helmets.

ZoneFlow™ technology

Extended-capture weld fume extraction technology extends the capture zone up to 1.5 m (5 ft.) deep and 1.2 m (4 ft.) wide (versus up to 457 mm (18 in.) from conventional source capture extractors). The increased capture zone reduces arm interactions so operators can keep welding, increasing arc-on time and productivity.

Found on the FILTAIR® Capture 5, and select FILTAIR® SWX and 4000–12000 models.



Millermatic® 141 and 211

See literature DC/12.42 (141) and DC/12.58 (211)



Millermatic 141



Millermatic 211



Multi-voltage plug (MVP™) allows connection to common 120- and 240-volt power receptacles without the use of any tools – simply choose the plug that fits the receptacle and connect to the power cord.



Mild Steel Welding Capability

Max. Model	141	211
Min.	4.8 mm (3/16 in.)	9.5 mm (3/8 in.)
	0.6 mm (24 ga.)	0.6 mm (24 ga.)

Aluminum Welding Capability

Max. Model	141	211
Min.	1.9 mm (14 ga.)	9.5 mm (3/8 in.)
	1.2 mm (18 ga.)	1.2 mm (18 ga.)

Aluminum welding with the Millermatic 141 uses optional Spoolmate 100 spool gun and 4043 series aluminum wire. Aluminum welding with the Millermatic 211 uses optional Spoolmate 100 spool gun with 4043 aluminum series wire or optional Spoolmate 150 spool gun with 4000 or 5000 series aluminum wire.

Recommended aluminum solution

Spoolmate 100 (300371) with both Millermatic models OR 150 (301272) with Millermatic 211.

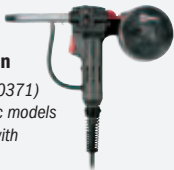

Auto-Set™ automatically provides the right settings to weld mild steel while **infinite voltage control** allows the flexibility to manually set your own parameters. Millermatic 211 model provides additional capabilities.

- Set the wire diameter (141: 0.6/0.8 mm [.024/.030 in.]) (211: 0.6/0.8/0.9 mm [.024/.030/.035 in.]), a blue light shows Auto-Set is activated
- Dial in the thickness of material you are welding
- Start welding with the exact parameters you need!

Angled cast-aluminum drive system with calibrated tension knob creates consistent feeding and easy setup with included 3 m (10 ft.) MIG gun or optional 4.6 m (15 ft.) M-150 MIG gun.

Quick Select™ drive roll makes setup quicker by offering three grooves – two for different size solid wire and a third for flux-cored wire.

Auto Spool Gun Detect™ automatically detects when a MIG gun or spool gun is connected eliminating the need for a switch.

Smooth-Start™ provides a smooth, spatter-free start.

Thermal overload protection shuts down unit and activates the **over temperature light** if airflow is blocked or duty cycle is exceeded. Automatically resets when unit cools.

Uses 102 or 203 mm (4 or 8 in.) spools.

Millermatic 211 model additional features

Advanced Auto-Set™ includes five different wire/gas combinations and 0.6/0.8/0.9 mm (.024/.030/.035 in.) wire capabilities.

Inverter technology combines best-in-class arc characteristics with the portability of a 17.2 kg (38 lb.) machine. The arc is extremely forgiving to variations in arc length and travel speeds.

Fan-On-Demand™ power source cooling system operates only when needed, reducing noise, energy use and the amount of contaminants pulled through the machine.

Light industrial ● CV DC 1 Phase

Processes

- MIG (GMAW) • Flux-cored (FCAW)

Comes complete with

- 3 m (10 ft.) 100-amp MDX™-100 MIG gun
- 3 m (10 ft.) work cable with clamp
- 2 m (6.5 ft.) power cord with plug (Millermatic 141) OR 2 m (6.5 ft.) power cord with MVP plugs for 120 V and 240 V (Millermatic 211)
- Quick Select™ drive roll for 0.6 mm (.024 in.) or 0.8/0.9 mm (.030/.035 in.) solid wire, and 0.8/0.9 mm (.030/.035 in.) flux-cored wire

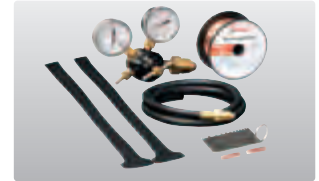

- Flow gauge regulator and gas hose for argon or AR/CO₂ mix, two 0.8 mm (.030 in.) contact tips, Hobart® spool of 0.8 mm (.030 in.) solid wire, hook-and-loop cord wraps and material thickness gauge (229895)

Most popular accessories

- Spoolmate™ 100 300371
- Spoolmate™ 150 301272 (Millermatic 211 only)



- Running Gear/Cylinder Rack 301239
- Protective Cover 301262
- V-Knurled Drive Roll 202926

Model/Stock Number	Input Power	Amperage Range	Rated Output	Amps Input at Rated Output, 50/60 Hz				Wire Feed Speed	Wire Type and Diameter Capacity	Power Source Dimensions	Power Source Net Weight
				120 V	240 V	KVA	KW				
Millermatic 141 (907612)	120 V	30-140	90 A at 18.5 VDC, 20% duty cycle	20	–	3.0	2.45	0.4-9.1 m/min. (15-360 ipm)	Solid steel 0.6-0.8 mm (.023-.030 in.) Stainless 0.6-0.8 mm (.023-.030 in.) Flux-cored 0.8-0.9 mm (.030-.035 in.)	H: 318 mm (12.5 in.) W: 286 mm (11.25 in.) D: 521 mm (20.5 in.)	23.1 kg (51 lb.)
Millermatic 211 (907614)	120 V	30-130	115 A at 19.8 VDC, 20% duty cycle	24.3	–	2.9	2.9	1.5-15.2 m/min. (60-600 ipm)	Solid steel 0.6-0.9 mm (.023-.035 in.) Stainless 0.6-0.9 mm (.023-.035 in.) Flux-cored 0.8-1.2 mm (.030-.045 in.)		17.2 kg (38 lb.)
	240 V	30-230	150 A at 21.5 VDC, 40% duty cycle	–	16.6	4.0	4.0				

Millermatic® 252

See literature DC/12.49



Welding Capability

Max. 13 mm (1/2 in.)	
Mild Steel	Aluminum
Min. 0.8 mm (22 ga.)	Min. 1.9 mm (14 ga.)

Aluminum welding uses optional Spoolmatic 15A or 30A spool gun.

Infinite voltage control with self-calibrating digital meters that permit presetting of voltage and wire feed speed. Ensures precise parameters and accuracy.

EXCLUSIVE! Auto-Gun Detect™ automatically adjusts voltage, wire speed and timers for faster switching between MIG, push-pull and spool guns.

Integrated digital timers come complete with presettable preflow/postflow, burnback, spot and delay (stitch) timers. Independent timers for MIG and spool gun.

Heavy-duty aluminum, two-drive-roll system.

Fan-On-Demand™ cooling system only operates when needed reducing power consumption and keeping internal components cleaner.

Superior aluminum MIG welding with direct connection of optional Spoolmate™ 200 and Spoolmatic®/Spoolmatic Pro spool guns or XR™ push-pull guns. No extra module to buy or install.

Recommended aluminum solution

Spoolmatic 15A (195156) or 30A (130831).

Industrial ● **CV DC 1** Phase

Processes

▪ MIG (GMAW) ▪ Flux-cored (FCAW)

Comes complete with

- 4.5 m (15 ft.), 250-amp MDX™-250 MIG gun
- 3 m (10 ft.) work cable with clamp
- 3 m (10 ft.) industrial power cord (and plug on 200/230 V model)
- Factory-installed gas solenoid
- Flow gauge regulator and gas hose for argon or AR/CO₂ mix
- Factory-installed lowered running gear/cylinder rack
- 0.8/0.9 mm (.030/.035 in.) reversible dual-groove drive rolls
- Extra contact tips

Most popular accessories

- Spoolmate™ 200 and Spoolmatic® Spool Guns
- XR™ Air-Cooled Push-Pull Guns
- Dual EZ-Change™ Low Cylinder Rack 300337
- Elevated Gun and Cable Rack 300335
- Protective Cover 195142
- 230-Volt 7.6 m Extension Cord 770644

Model/Stock Number	Amperage Range	Rated Output	Amps Input at Rated Output, 60 Hz				Wire Feed Speed	Wire Type and Diameter Capacity	Dimensions	Net Weight		
			200 V	230 V	460 V	575 V					KVA	KW
(907321) 200(208)/230 V	30-300	200 A at 28 VDC, 60% duty cycle	48	42	—	—	9.5	7.5	1.3-17.8 m/min. (50-700 ipm)	Solid steel 0.6-1.2 mm (.023-.045 in.) Stainless 0.6-1.2 mm (.023-.045 in.) Flux-cored 0.8-1.2 mm (.030-.045 in.)	H: 762 mm (30 in.) W: 483 mm (19 in.) D: 1,016 mm (40 in.)	94 kg (205 lb.)
(907322) 230/460/575 V		250 A at 28 VDC, 40% duty cycle	—	46	23	18	9.5	7.5				

Miller recommends



Hobart® aluminum filler metals — wire and cut lengths — have been designed to provide the best performance for the best welds. These products are backed by the deep industry knowledge of Hobart welding specialists who can help customers find the right aluminum filler metal solution. Every time. No matter how challenging the application.

Visit **HobartBrothers.com** or your local distributor to learn more.

Questions? Hobart is here to help.

Millermatic® 255

See literature DC/12.8



Millermatic 255 with running gear package shown.

Welding Capability

Max. 13 mm (1/2 in.)	Max. 13 mm (1/2 in.)
Mild Steel	Aluminum
Min. 0.6 mm (24 ga.)	Min. 1.2 mm (18 ga.)

Aluminum welding uses optional XR-Aluma-Pro push-pull gun.

Recommended aluminum solution

XR-Aluma-Pro™ push-pull gun



Easy-to-understand interface with 7-inch color LCD display ensures proper machine setup and parameter selection, reducing setup time and increasing weld time.

- Quick-access Auto-Set and pulse mode backlit buttons across the top illuminate when active
- Soft-key buttons below the display change function depending on which screen is displayed – makes setup or change quick, easy and intuitive
- Large text for easier readability
- Intuitive connection setup images
- Full troubleshooting descriptions versus help errors and look up codes

AUTO-LINE TECHNOLOGY Allows for any input voltage hookup (208–240 V, single-phase) with no manual linking, providing convenience in any job setting. Ideal solution for dirty or unreliable power.

Auto-Set™ Elite offers predefined weld settings to increase ease of use and ensure that the job is done right for operators of all skill levels.

- Available for MIG and pulsed MIG processes with the ability to fine-tune your settings
- Set weld parameters by selecting wire and gas type, wire diameter and material thickness

Built-in pulsed MIG programs. All programmed information is restored after each power up – aluminum/steel/stainless steel.

Program mode allows easy save and recall of favorite weld settings. Delivers more productivity and consistent quality while minimizing supervisor intervention.

EXCLUSIVE! Auto-Gun Detect™ automatically adjusts voltage, wire speed and timers for faster switching between MIG, push-pull and spool guns.

Heavy-duty aluminum two-drive-roll system.

Fan-On-Demand™ cooling system only operates when needed, reducing power consumption and keeping internal components cleaner.

Industrial ● **3C** **CV** **DC** **1** Phase

Processes

- MIG (GMAW) • Flux-cored (FCAW)
- Pulsed MIG (GMAW-P)

Millermatic 255 comes complete with

- 4.5 m (15 ft.) 250-amp MDX™-250 MIG gun with Bernard® AccuLock™ S consumables
- 3 m (10 ft.) work cable with clamp
- 3 m (10 ft.) industrial power cord
- Factory-installed gas solenoid
- Flow gauge regulator and gas hose for argon or AR/CO₂ mix
- Chain to secure gas cylinder
- .035/.045 in. reversible V-groove drive rolls
- Extra contact tips and material thickness gauge (229895)

Most popular accessories

- MDX™-250 EZ-Select™ MIG Gun 1770047
- Spoolmatic® Spool Guns
- XR-Aluma-Pro™ Air-Cooled Push-Pull Guns
- EZ-Latch™ Single Cylinder Running Gear 301449
- EZ-Latch™ Dual Cylinder Rack and Cable Holder 301481
- Protective Cover 301521

Stock Number (907734) 208–240 V	Amperage Range	Rated Output	Amps Input at Rated Output, 50/60 Hz				Wire Feed Speed	Wire Type and Diameter Capacity	Power Source Dimensions	Power Source Net Weight
			208 V	240 V	KVA	KW				
	20–350	230 A at 25.5 V, 60% duty cycle	44.0	39.5	9.5	7.2	1.3–20 m/min. (50–800 ipm)	Solid steel 0.6–1.2 mm (.023–.045 in.) Stainless 0.6–1.2 mm (.023–.045 in.) Aluminum 0.9–1.2 mm (.035–.047 in.) Flux-cored 0.8–1.2 mm (.030–.045 in.)	H: 489 mm (19.24 in.) W: 349 mm (13.75 in.) D: 667 mm (26.25 in.)	38 kg (84 lb.)

Millermatic® 355

See literature DC/12.95

NEW!



Millermatic 355 with MIG gun package shown (ALL packages include running gear).

Welding Capability

Max. 13 mm (1/2 in.)	Max. 13 mm (1/2 in.)
Mild Steel	Aluminum
Min. 0.8 mm (22 ga.)	Min. 1.2 mm (18 ga.)

Aluminum welding uses optional XR-Aluma-Pro push-pull gun.



Recommended aluminum solution

XR-Aluma-Pro™ push-pull gun.



Easy-to-understand interface with 178 mm (7 in.) color LCD display ensures proper machine setup and parameter selection, reducing setup time and increasing weld time.

- Quick-access Auto-Set and pulse mode backlit buttons across the top illuminate when active
- Soft-key buttons below the display change function depending on which screen is displayed – makes setup or change quick, easy and intuitive
- Large text for easier readability
- Intuitive connection setup images
- Full troubleshooting descriptions versus help errors and look up codes

Single- or three-phase input power provides versatility to utilize any North American power (208, 240, 460, 575 V).

Input voltage selection switch located in the wire drive compartment provides the ability to manually switch input voltage.

Built-in pulsed MIG programs. All programmed information is restored after each power up – steel/stainless steel/aluminum/metal core/silicon bronze.

Auto-Set™ Elite offers predefined weld settings to increase ease of use and ensure that the job is done right for operators of all skill levels.

- Available for MIG and pulsed MIG processes with the ability to fine-tune your settings
- Set weld parameters by selecting wire and gas type, wire diameter and material thickness

Program mode allows easy save and recall of favorite weld settings. Delivers greater productivity and consistent quality while minimizing supervisor intervention.

Trigger program select increases productivity by eliminating the need to go back to machine to change weld settings. Simply tap gun trigger to select the program.

EXCLUSIVE! Auto-Gun Detect™ automatically adjusts voltage, wire speed and timers for faster switching between MIG, push-pull and spool guns.

Heavy-duty aluminum four-drive-roll system.

Uses 102, 203 or 305 mm (4-, 8- or 12-inch) spools.

Fan-On-Demand™ cooling system only operates when needed, reducing power consumption and keeping internal components cleaner.

Optional demo cable kit (sold separately) powers the display through USB to train users in a quiet conference room or showroom versus connecting to shop power in a noisy work environment.

Industrial **CV DC 3 1**
Phase Phase

Processes

- MIG (GMAW) ▪ Flux-cored (FCAW)
- Pulsed MIG (GMAW-P)

Comes complete with

- 4.5 m (15 ft.) 300-amp Bernard® BTB MIG gun with AccuLock™ S consumables and reversible V-groove drive rolls for 0.9/1.2 mm (.035/.045 in.) wire
- **OR** 7.6 m (25 ft.) XR-Aluma-Pro™ air-cooled push-pull MIG gun with Miller® FasTip™ consumables and reversible U-grooved drive rolls for 0.9 and 1.2 mm (.035 and .047 in.) aluminum wire
- EZ-Latch™ single cylinder running gear
- 3 m (10 ft.) work cable with clamp
- 2.7 m (9 ft.) industrial power cord
- Factory-installed gas solenoid
- Flow gauge regulator and gas hose for argon or AR/CO₂ mix
- Chain to secure gas cylinder
- Extra contact tips and material thickness gauge (229895)

Most popular accessories

- MDX™-250 EZ-Select™ MIG Gun 1770047
- Bernard® MIG Guns
- Spoolmate™ 200 Spool Gun
- Spoolmatic® Spool Gun (non-Pro gun only)
- XR-Aluma-Pro™ Air-Cooled Push-Pull Guns
- XR™-Pistol-Pro Air-Cooled Push-Pull Guns



- **EZ-Latch™ Dual Cylinder Rack with Elevated Gun and Cable Rack** 301481

Converts an EZ-Latch Single Cylinder Running Gear into a Dual Cylinder Rack Running Gear



- **Demo Cable Kit** 289696

*See literature DC/12.95 for dimensions and weight with running gear.

Stock Number (907808) 208/240/460/575 V	Input Power	Amp/Volt Ranges	Rated Output	Amps Input at Rated Output, 50/60 Hz 208 V 240 V 460 V 575 V KVA KW	Max. Open-Circuit Voltage	Wire Feed Speed	Wire Type and Diameter Capacity	Power Source Dimensions*	Power Source Net Weight*
	Three-phase	20-400 A 12-34 V	310 A at 29.5 VDC, 60% duty cycle	32.3 28.8 18.2 15.4 15.3 11.5	90 VDC	1.3-20 m/min. (50-800 ipm)	Solid steel 0.9-1.2 mm (.035-.045 in.)	H: 489 mm (19.25 in.) W: 349 mm (13.75 in.) D: 667 mm (26.25 in.)	45 kg (99 lb.)
	Single-phase, 460 or 575 V	20-400 A 12-34 V	– – 35.6 32.3 15.0 11.1	Stainless 0.6-1.2 mm (.023-.045 in.)					
	Single-phase, 208 or 240 V	20-350 A 12-32 V	69.6 62.5 – – 15.0 11.1	Aluminum 0.9-1.2 mm (.035-.047 in.)					
							Flux-cored 0.9-1.2 mm (.035-.045 in.)		
							Metal-core 1.2-1.3 mm (.045-.052 in.)		
							Silicon bronze 0.8-0.9 mm (.030-.035 in.)		

AlumaFeed® Synergic Aluminum Welding System

See literature DC/34.0

Dedicated aluminum system for the most advanced MIG and synergic pulsed MIG performance.



AlumaPower™ 350 MPa and XR-AlumaFeed® SuitCase® with XR-Aluma-Pro gun air-cooled shown.

AUTO-LINE TECHNOLOGY AlumaPower™ 350 model allows for any input voltage hookup (208–575 V, single- or three-phase) with no manual linking, providing convenience in any job setting. Ideal solution for dirty or unreliable power. 450 model is 230/460 V manual link or 575 V, three-phase only.

Impact-resistant and flame-retardant suitcase-style feeder.

Synchronized, true push-pull wire feed system for precise wire feeding and arc performance.

Profile Pulse™ provides TIG appearance with MIG simplicity and productivity. Achieve “stacked dimes” without gun manipulation. Profile Pulse frequency can be changed to increase or decrease the spacing between the ripple pattern to achieve the desired weld appearance.



Synergic pulsed MIG. As wire speed increases/decreases, pulse parameters also increase/decrease to match the right amount of power needed, eliminating the need to make additional adjustments.

Built-in MIG and pulsed MIG programs automatically set the optimal parameters for a wide variety of wires making it easy to set up and use.

Parameter and system locks enhance quality assurance and protect weld consistency.

Trigger schedule select allows operator to change between two sets of weld parameters.

Heavy industrial
CV DC 3 1 AlumaPower 450
 Phase Phase is 3-phase only.

Processes

- Aluminum MIG (GMAW)
- Aluminum pulsed MIG (GMAW-P)

Most popular accessories

- XR™ Push-Pull Guns
- MIGRunner™ Cart 195445
- Coolmate™ 3 043007
- Coolant 043810
- Industrial MIG 4/0 Kits
 - 300405 With Dinse connectors (350 MPa only)
 - 300390 With lug connectors (450 MPa only)
- Consists of flowmeter regulator with 3 m (10 ft.) gas hose, 3 m (10 ft.) 4/0 feeder weld cable, and 4.6 m (15 ft.) work cable with 600-amp C-clamp
- Extension Cables
 - 247831025 7.6 m (25 ft.)
 - 247831050 15 m (50 ft.)
 - 247831080 24.4 m (80 ft.)
- 1.6 mm (1/16 in.) Liner and Wire Kit for Gun 230708
- 1.6 mm (1/16 in.) Drive Roll Kit for Control Box 195591
- For gun and feeder remote options, see literature DC/34.0 or visit MillerWelds.com

Models

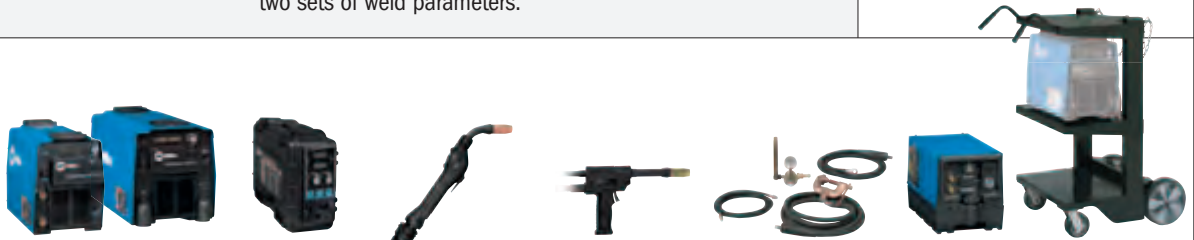

Power Source Only Stock Number		XR-AlumaFeed SuitCase Feeder	XR-Aluma-Pro™ Push-Pull MIG Gun	XR™-Pistol Grip Push-Pull MIG Gun	Industrial MIG 4/0 Kit	Coolmate™ with Coolant	Cart
AlumaPower 350 MPa (907420) 208–575 V (907420001) 208–575 V with auxiliary power	(301593), CE	(301567)	7.6 m (25 ft.) air-cooled	–	–	–	–
	(301593), CE	(301567)	–	9 m (30 ft.) air-cooled	–	–	–
	(301593), CE	(301567)	7.6 m (25 ft.) air-cooled	–	With Dinse connectors	–	MIGRunner cart
AlumaPower 450 MPa (907483) 230/460 V w/auxiliary power	(301593), CE	(301567)	7.6 m (25 ft.) air-cooled	–	With lug connectors	–	MIGRunner cart
	(301593), CE	(301567)	25 ft. water-cooled	–	With lug connectors	Coolmate 3	MIGRunner cart

Model	Input Power	Amp/Volt Ranges	Rated Output	Amps Input at Rated Load Output, 60 Hz					KVA	KW	Max. Open-Circuit Voltage	Dimensions	Net Weight
				208 V	230 V	400 V	460 V	575 V					
AlumaPower 350 MPa	Three-phase	5–425 A 10–38 V	350 A at 34 VDC, 60% duty cycle	40.4	36.1	20.6	17.8	14.1	14.2	13.6	75 VDC	H: 432 mm (17 in.) W: 318 mm (12.5 in.) D: 610 mm (24 in.)	36.3 kg (80 lb.)
	Single-phase	5–425 A 10–38 V	300 A at 32 VDC, 60% duty cycle	60.8	54.6	29.7	24.5	19.9	11.7	11.2			
AlumaPower 450 MPa	Three-phase	15–600 A 10–38 V	450 A at 36.5 VDC, 100% duty cycle	–	49.4	–	27.2	23.6	21.6 (23.5 on 575 V)	18.3	90 VDC	H: 438 mm (17.25 in.) W: 368 mm (14.5 in.) D: 689 mm (27.125 in.)	55.3 kg (122 lb.)
XR-AlumaFeed SuitCase Feeder	Input Power	Input Welding Circuit Rating	Wire Feed Speed	Wire Diameter Capacity					Maximum Spool Size Capacity	Dimensions	Net Weight		
				24 VAC, 5 A, 50/60 Hz	400 A at 100% duty cycle System duty cycle is limited to gun rating	1.3–23 m/min. (50–900 ipm)	0.9–1.6 mm (.035–1/16 in.) Requires wire kit (230708) for gun and drive roll kit (268850) for control box to run 1.6 mm (1/16 in.) wire					305 mm (12 in.)	H: 394 mm (15.5 in.) W: 229 mm (9 in.) D: 533 mm (21 in.)

Deltaweld® Systems See literature DC/16.5

The new standard in manufacturing provides the solution for welders of all skill levels, plus pulsed MIG capabilities with Intelx™ Pro integrated systems.

*Deltaweld 350 System
MIGRunner with single-wire
Intelx Pro feeder shown.*



**Reduce the time and hassle of setting up welding systems.
Make your move to a weld-ready Deltaweld MIGRunner™.**

Ships as a complete package.

Just hook up your primary power, add gas, wire and welding gun, and you're ready to weld.

Versatile MIGRunner cart keeps you organized with its dual cylinder rack, MIG gun holders and spacious storage compartment beneath the power source, and portable with its lockable front casters and oversized rear wheels.

Old Deltaweld® System



Time spent assembling old Deltaweld package

New Deltaweld® System



Time spent assembling new Deltaweld package



Quality-engineered cable management protects your connections to keep you productive.



Single-wire feeder swivels for convenience and function, eliminating wear on gun and liner assembly. It moves with the MIG gun, allowing operator to see the front of the feeder and which parameters are selected.

Deltaweld® Power Sources

Two power source choices

- **Deltaweld 350** has auxiliary power standard and optional 14-pin receptacle and meters for use with legacy feeders.
- **Deltaweld 500** has auxiliary power and meters standard and an optional 14-pin receptacle. It adds more power (500 amps at 100 percent duty cycle) and a dedicated gouge mode for up to 9.5 mm (3/8 in.) carbons.

ArcConnect™ is a next generation communication that utilizes high-speed signals to improve weld performance and allow point-of-use controls to be located at the feeder.

Wind Tunnel Technology™ Internal air flow that protects components, greatly improving reliability.

Fan-On-Demand™ cooling system only operates when needed, reducing power consumption and keeping internal components cleaner.

Welding Intelligence™ Get more done, produce higher-quality welds and control costs with Insight Core (factory-installed option on select models). Gives owners/managers visibility of welder productivity, so they can make informed decisions to drive improvements.



Deltaweld 350

Deltaweld 500

Intellex™ Wire Feeders



Intellex single-wire feeder Intellex Pro single-wire feeder Intellex and Intellex Pro dual-wire feeders

Dedicated wire feeder options

- **Intellex™ feeders** with arc control feature means welders can produce better welds with minimal parameter adjustments.
- **Intellex™ Pro feeders** add Accu-Pulse®, EZ-Set, steel weld programs, and memory buttons. Accu-Pulse® provides a 28 percent wider operating window and a more forgiving arc, while EZ-Set simplifies parameter setup based on material thickness, removing complexity.

Dual-wire models allow two different wire types to be available on one feeder, avoiding downtime from changing spools and drive rolls.

User-friendly interface makes the system easy to set up and adjust with minimal training.

Rotatable drive assembly allows operator to rotate the drive, eliminating severe bends in the wire feed path. This extends gun-liner life and aids in feeding difficult wires.

Balanced-pressure drive-roll design and tensioners feed wire in its truest and straightest form for consistent feedability and better welding performance.

Intellex Feeder Features

Feature	Intellex	Intellex Pro
Digital meters	●	●
Remote voltage	●	●
Wire feed speed	●	●
Arc control	●	●
Trigger hold	●	●
Wire jog and purge	●	●
Wire feed speed feedback	●	●
Four drive rolls	●	●
Rotatable drive	●	●
Up to 60 lb. spool	●	●
MIG process	●	●
Dual-wire models	●	●
EZ-Set MIG		●
EZ-Set Accu-Pulse®		●
Trigger select		●
Preflow		●
Postflow		●
Memory slots (2)		●
Out-of-box programs (steel only)		●

Intellex™ Pro Swingarc™

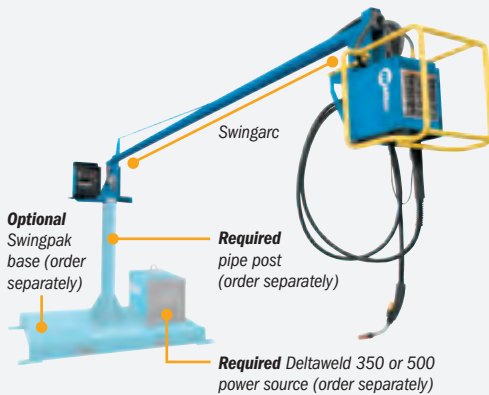

Single- and dual-wire models with 3.7 or 4.9 m (12 or 16 ft.) booms are sized to accommodate a variety of weld cell layouts (7.3 or 9.8 m [24 or 32 ft.] diameter work area).

Counterbalance design makes it easy to position boom and **360-degree rotation and 60-degree lift angle** maximize work area.

In-boom cable routing organizes hoses and cables for a cleaner work environment.

Intellex Pro Swingarc 3.7 m (12 ft.) Single	Intellex Pro Swingarc 3.7 m (12 ft.) Dual	Intellex Pro Swingarc 4.9 m (16 ft.) Single
(301556) Boom	(301557) Boom	(301558) Boom
(301552) ROI	(301553) ROI	(301552) ROI
(301554) Wire Drive	(301555) Wire Drive	(301554) Wire Drive

Heavy Industrial ● CV DC 3 Phase

Processes

- MIG (GMAW) = Flux-cored (FCAW)
- Accu-Pulse® MIG (GMAW-P) with Intellex Pro feeder
- Air carbon arc gouging (CAC-A) with Deltaweld 500

MIGRunner™ packages include

- Deltaweld power source
350: 907747
500: 907785 or 907786
- Intellex **OR** Intellex Pro single-wire or dual-wire feeder
- Bernard® BTB Gun(s) (350: 300 A **OR** 500: 400 A) and 0.9/1.2 mm (.035/.045 in.) V-groove drive rolls
- Factory-installed Deltaweld running gear with cable holder, gun holders, and chains for gas cylinders
- Cart accessory kit consisting of flowmeter regulator(s) with 1.5 m (5 ft.) gas hose(s), 3 m (10 ft.) 4/0 feeder weld cable with lugs, 4.6 m (15 ft.) work cable with 600-amp C-clamp, and 2.7 m (9 ft.) ArcConnect cable
- Quick-setup guide and video

Most popular accessories

- Bernard® MIG Guns
- Deltaweld 350/500 Running Gear 301523
- Industrial MIG 4/0 Kits with lugs (stationary packages only)
- ArcConnect Control/Motor Cables 280471009 2.7 m (9 ft.)
280471015 4.6 m (15 ft.)
280471025 7.6 m (25 ft.)
280471050 15.2 m (50 ft.)
280471075 22.9 m (75 ft.)
280471100 30.5 m (100 ft.)
- Cart Accessory Kit 301528 (see above for contents)
Note: For dual-wire feeder kit both 301528 and 301579 are required.
- Feeder Swivel Kit 301533
Mounts single- or dual-wire feeder to Deltaweld – only single feeder swivels
- Stationary Handle Kit 301529
- Hanging Bail 058435
- Pipe Post with 457 mm (18 in.) Base 149838 1.2 m (4 ft.)
149839 1.8 m (6 ft.)
- Swingpak™ Base 183997
- Single/Dual Spool Carrier 300353 For 1.2 m (4 ft.) post
300352 For 1.8 m (6 ft.) post

350 A	Power Source Only/Stock Number Most Popular Models ◀	Amp/Volt Ranges	Rated Output	Amps Input at Rated Load Output, 60 Hz						Power Source Dimensions (Includes lift eye)	Power Source Net Weight
	208/230/460 V, 60 Hz	20–400 A 10–38 V	300 A at 29 VDC, 100% duty cycle 350 A at 31.5 VDC, 60% duty cycle 425 A at 35.25 VDC, 30% duty cycle	208 V	230 V	460 V	575 V	KVA	KW	H: 568 mm (22.36 in.) W: 390 mm (15.35 in.) D: 740 mm (29.15 in.)	52.2 kg (115 lb.)
500 A	Deltaweld 500 (907785) ◀ 208/230/460 V, 60 Hz with meters (907785001) 208/230/460 V with 14-pin and meters (907785002) 208/230/460 V w/meters and Insight Core	30–650 A 10–44 V	500 A at 39 VDC, 100% duty cycle 575 A at 42.75 VDC, 60% duty cycle 650 A at 44 VDC, 25% duty cycle	64.2	58.1	30.4	24.8	24.2	21.7	H: 568 mm (22.36 in.) W: 390 mm (15.35 in.) D: 804 mm (31.65 in.)	65.8 kg (145 lb.)
				94.2	84.9	43.9	34.9	35.0	31.6		

Feeder Only/Stock Number	Input Power	Input Welding Circuit Rating	Wire Feed Speed	Wire Diameter Capacity	Maximum Spool Size Capacity	Dimensions (H x W x D)	Net Weight
Intellex (301493) Single-wire Intellex Pro (301492) ◀ Single-wire Intellex (301541) Dual-wire Intellex Pro (301540) Dual-wire	50 VDC	600 A at 113 VDC, 60% duty cycle	1.3–19.8 m/min. (50–780 ipm)	0.6–2.0 mm (.023–5/64 in.)	457 mm (18 in.), 27 kg (60 lb.)	Single: 413 x 314 x 708 mm (16.25 x 12.38 x 27.88 in.) Dual: 356 x 457 x 876 mm (14 x 18 x 34.5 in.)	Single: 20.3 kg (44.8 lb.) Dual: 34.9 kg (77 lb.)

Invision™ MPa Plus System See literature DC/23.6

MIG and synergic pulsed MIG system with optimized weld programs for both steel and aluminum.



Invision 352 MPa with S-74 MPa Plus feeder shown.



Recommended Aluminum Solution

Dedicated XR Plus guns work with MPa Plus feeders to coordinate wire feed speed of the gun and the feeder. This provides optimized aluminum feeding and welding performance.



AUTO-LINE TECHNOLOGY Invision 352 model allows for any input voltage hookup (208-575 V, three-phase) with no manual linking, providing convenience in any job setting. Ideal solution for dirty or unreliable power. 450 model is 400 V, three-phase.

Built-in MIG and pulsed MIG programs automatically set the optimal parameters for a wide variety of wires making it easy to set up and use.

Synergic pulsed MIG. As wire speed increases/decreases, pulse parameters also increase/decrease to match the right amount of power needed, eliminating the need to make additional adjustments.

Profile Pulse™ provides TIG appearance with MIG simplicity and productivity. Achieve “stacked dimes” without gun manipulation. Profile Pulse frequency can be changed to increase or decrease the spacing between the ripple pattern to achieve the desired weld appearance.



Easy to set up. Select wire diameter, wire type and gas being used, set your wire speed and strike an arc.

Wind Tunnel Technology™ Air flow that protects internal components, greatly improving reliability.

Fan-On-Demand™ cooling system operates only when needed, reducing noise, energy use and amount of contaminants pulled through machine.

Heavy industrial 

Processes

- MIG (GMAW) ▪ Flux-cored (FCAW)
- Pulsed MIG (GMAW-P)
- Air carbon arc gouging (CAC-A) (Invision 352: 6.4 mm [1/4 in.] carbons) (Invision 450: 7.9 mm [5/16 in.] carbons)

Invision MPa System consists of the following (sold separately)

- Invision 352 MPa power source (907431002) **OR** 450 MPa power source (907524)
- 70 Series MPa Plus feeder
- XR-Aluma-Pro™ Plus or XR™-Pistol Plus push-pull gun
- Coolmate™ 3 cooling system with coolant (water-cooled systems only)

Most popular accessories

- XR™ Push-Pull Guns
- MIGRunner™ Cart 195445
- Coolmate™ 3 043007
- Extension Cables
 - 247831025 7.6 m (25 ft.)
 - 247831050 15 m (50 ft.)
 - 247831080 24.4 m (80 ft.)
- 1.6 mm (1/16 in.) Liner and Wire Kit for Gun 230708
- Running Gear Cylinder Rack 300408
- S-74 MPa Plus 300577, **CE**
- D-74 MPa Plus 300578, **CE**
- MIG 4/0 Cable Kit with Dinse 300405
- MIG 4/0 Cable Kit with lug connectors 300390

Model/Stock Number	Amp/Volt Ranges	Rated Output	Amps Input at Rated Load Output				KVA	KW	Max. Open-Circuit Voltage	Dimensions	Net Weight
			230 V	400 V	460 V	575 V					
Invision 352 MPa (907431) , 50/60 Hz (907431001) with auxiliary power, 50/60 Hz (907431002) 230-575 V with auxiliary power, 50/60 Hz, CE	5-425 A 10-38 V	350 A at 34 VDC, 60% duty cycle	36.1	20.6	17.8	14.1	14.2	13.6	75 VDC	H: 432 mm (17 in.) W: 318 mm (12.5 in.) D: 610 mm (24 in.)	36.3 kg (80 lb.)
Invision 450 MPa (907485) 230/460 V with auxiliary power, 60 Hz (907524) 400 V with auxiliary power, 50/60 Hz, CE	15-600 A 10-38 V	450 A at 36.5 VDC, 100% duty cycle	49.4	—	27.2	23.6	21.6	18.3	90 VDC	H: 438 mm (17.25 in.) W: 368 mm (14.5 in.) D: 689 mm (27.125 in.)	55.3 kg (122 lb.)

Continuum™ Systems

See literature DC/36.0

Next generation of advanced industrial welding solutions improves productivity through weld quality, ease of use and system flexibility.



Continuum 350 shown with Continuum single-wire feeder. Filler metal sold separately.

More power – better reliability

Up to 26 percent more welding output (than competitive models) for demanding industrial applications.

Power source design

Smart and powerful digital design has the fast response needed to deliver the most stable welding performance for better welding results.

Flexible to meet current and future needs with integrated expansion capabilities.

Welding Intelligence™ Increase productivity, improve quality and manage costs with Insight Core™ (standard) and Insight Centerpoint™ (optional) welding information management systems.

Feeder design

Tru-Feed™ technology provides precise feeding operation for stable arc performance.

- **Low-inertia motor** provides faster response for the best arc starts with the least amount of spatter
- **Balanced-pressure drive-roll design and tensioners** feed wire in its truest and straightest form for consistent feedability, resulting in better welding performance

User interface makes the system easy to set up and adjust with minimal training.

Continuum Processes

Best For	Standard Spray	High-Deposition MIG	Accu-Pulse	Versa-Pulse	Short Circuit	RMD
Deposition	A	A	A	B	D	D
Gap Filing	D	D	B	B	A	A
Low Heat Input	D	C	B	A	A	A
Out-of-Position Welds			A	B	B	B
Low Spatter	A	A	A	B	C	B
Thick Metals	A	A	A	C	D	D
Thin Metals			B	A	A	A
Increased Travel Speed	A	A	A	A	B	C

HOT COLD

Note: As the technological advances offered by Continuum extend beyond the capability of Access® systems, the two systems are not compatible. Continuum systems are designed to allow future upgradability, to expand with your operation's needs.

Ratings A, B, C, and D are relative values. An "A" rating indicates a best fit between your performance needs and process. A "blank" rating indicates that the process is not recommended for that application.

Accu-Pulse is the most popular process for majority of industrial welding applications.

Versa-Pulse is a fast, low-heat, low-spatter process designed for thin-material applications.

RMD is a low-heat modified short-circuit process designed to fill gaps with thin-material applications.

High-deposition MIG provides increased deposition rates over standard spray on thicker materials.

Heavy industrial

Processes

- Accu-Pulse® MIG (GMAW-P)
- Versa-Pulse™ ▪ RMD® ▪ MIG (GMAW)
- High-deposition MIG (GMAW)
- Flux-cored (FCAW)
- Air carbon arc gouging (CAC-A)

Most popular accessories

- Bernard™ MIG Guns
- Insight Centerpoint™ Software
- Continuum Running Gear/Cylinder Rack 301264
- Continuum Integrated Cooler 301214, **CE**
Mounts to bottom of Continuum power source. Does not require external power.
- Continuum Control/Motor Cables
263368003 0.9 m (3 ft.)
263368015 4.6 m (15 ft.)
263368020 6.1 m (20 ft.)
263368025 7.6 m (25 ft.)
263368050 15 m (50 ft.)
263368080 24.4 m (80 ft.)
263368100 30.5 m (100 ft.)
- Industrial MIG 4/0 Kit 300390
- Continuum Feeders
301195 Single
301195010 Single, **CE**
301199 Dual
301199010 Dual, **CE**
- Continuum Swingarc™
Boom Single
301219 2.4 m (8 ft.)
301220 3.7 m (12 ft.)
301221 3.9 m (16 ft.)
ROI Single
301227, **CE**
Boom Dual 3.7 m (12 ft.) 301223
ROI Dual 301434, **CE**
- Pipe Post
149838 1.2 m (4 ft.)
149839 1.8 m (6 ft.)

*While idling.

Model	Stock Number	Amperage/ Voltage Range	Rated Output	Amps Input at Rated Output, 50/60 Hz, 3-Phase							Max. Open-Circuit Voltage	Net Weight (power source only)
				230V	380V	400V	460V	575V	KVA	KW		
Continuum 350	(907636) 230-575 V Machine only (907636001) 230-575 V w/running gear (907645) 400 V, CE	20-400 A, 10-44 V	300 A at 34 VDC, 100% duty cycle	36.7	21.8	20.8	18.8	14.6	14.4	13.8	75 VDC	57.6 kg (127 lb.)
				0-1*	0-1*	0-1*	0-1*	0-1*	0.8*	0.17*		
Continuum 500	(907640) 230-575 V Machine only (907640001) 230-575 V w/running gear (907648) 400 V, CE	20-600 A, 10-44 V	500 A at 40 VDC, 100% duty cycle	34.9	–	33.2	28.9	23.3	23.1	21.9	67.1 kg (148 lb.)	
				0-1*	–	0-1*	0-1*	0-1*	0.8*	0.17*		

Model	Stock Number	Input Power	Input Welding Circuit Rating	Wire Feed Speed	Wire Diameter Capacity	Max Spool Size Capacity	Dimensions	Net Weight
Continuum Feeder only	(301195) Single-wire model (301195010) Single-wire model, CE (301199) Dual-wire model (301199 010) Dual-wire model, CE	50 VDC	500 A at 100% duty cycle	Standard: 1.3-25.4 m/min. (50-1000 IPM)	0.9-2.0 mm (.035-5/64 in.)	457 mm (18 in.), 27 kg (60 lb.)	H: 351 mm (13.812 in.) Single W: 414 mm (16.312 in.) Dual W: 432 mm (17 in.) D: 754 mm (29.687 in.)	Single 19.5 kg (43 lb.) Dual 27.9 kg (61.5 lb.)

Auto-Continuum™ Systems See literature AU/10.0

Next generation automation welding solution delivers advanced arc performance to improve throughput and weld quality.



Auto-Continuum 500 shown with robot arm (not included) and Auto-Continuum wire drive motor assembly.

Closeup of Auto-Continuum wire drive motor assembly (left-hand drive).

Note: As the technological advances offered by Auto-Continuum extend beyond the capability of Access® systems, the two systems are not compatible. Continuum systems are designed to allow future upgradability, to expand with your operation's needs.

More power – better reliability. Up to 26 percent more welding output (than competitive models) for demanding industrial applications.

AUTO-LINE TECHNOLOGY Allows for any input voltage hookup (230–575 V, three-phase) with no manual linking, providing convenience in any job setting. Ideal solution for dirty or unreliable power.

Improve work environment and reduce spatter. Versa-Pulse and Accu-Pulse processes reduce fume generation, and by precisely controlling the welding arc they also reduce spatter size and quantity. Fume generation can be reduced up to 50 percent over traditional CV MIG.

- **Versa-Pulse** is a fast, low-heat, low-spatter process for high-speed automation on thin materials and is great for gap filling
- **Accu-Pulse** is better for out-of-position welds, provides higher deposition rates and is designed for thicker materials than Versa-Pulse

Easy communication from robot to power source.

Designed for easy integration with fixed and flexible automation.

Fleet standardization. Auto-Continuum can be used for both automation and hand-held applications.

Welding Intelligence™ Increase productivity, improve quality and manage costs.

- **Insight Core™** (standard) is a simplified, Internet-based welding information solution that reports cell productivity and weld parameter verification
- **Insight Centerpoint™** (optional) is an advanced, real-time feedback solution to ensure consistent weld quality and actively detects a bad weld when it happens, reducing rework costs and improving quality

Heavy industrial **CV DC 3** Phase

Processes

- Accu-Pulse® MIG (GMAW-P)
- Versa-Pulse™ • RMD® • MIG (GMAW)
- High-deposition MIG (GMAW)
- Flux-cored (FCAW)

Most popular accessories

- Insight Centerpoint™ Software
- Auto-Continuum Robotic MIG Kit 301455
Consists of 7.6 m (25 ft.) motor control cable, 3.7 m (12 ft.) motor control extension, two 9 m (30 ft.) weld cables, 3.7 m (12 ft.) weld cable extension, 9 m (30 ft.) gas hose, flowmeter regulator, 5 m (16.4 ft.) Ethernet cable, 0.9/1.2 mm (.035/.045-in.) V-groove drive roll kit with guides, and conduit assembly with quick disconnects.
- Wire Drive Motor Mounting Brackets
301276 ABB® 1600
301277 ABB® 2600
300483 FANUC® 100 and 120 IC
300013 FANUC®/KUKA®/Motoman®
301282 KUKA® KR5 HW
301275 KUKA® KR16 HW
300375 Motoman® EA1400
300376 Motoman® EA1900
- Motor Control Cables
263368025 7.6 m (25 ft.)
263368050 15 m (50 ft.)
263368080 24.4 m (80 ft.)
263368100 30.5 m (100 ft.)
- EtherNet/IP™ Communication Cables
300734 3 m (9.8 ft.)
300735 5 m (16.4 ft.)
300736 10 m (32.8 ft.)
- DeviceNet Communication Cables
300020 2.7 m (9 ft.)
300021 6.1 m (20 ft.)
- Analog Interface 301547

*While idling.

Model	Stock Number	Amp/Volt Ranges	Rated Output	IP Rating	Amps Input at Rated Output, 50/60 Hz, 3-Phase							Max. Open-Circuit Voltage	Dimensions (Includes lift eye)	Net Weight
					230 V	380 V	400 V	460 V	575 V	KVA	KW			
Auto-Continuum 350	(907656) EtherNet/IP™	20–400 A, 10–44 V	350 A at 31.5 VDC, 100% duty cycle	IP23	36.7	21.8	20.8	18.8	14.6	14.4	13.8	75 VDC	H: 27.187 in. (691 mm) W: 17.5 in. (444 mm) D: 28.22 in. (717 mm)	59.4 kg (130 lb.)
	(907658) EtherNet/IP™ with auxiliary power (907660) EtherNet/IP™, CE				0–1*	0–1*	0–1*	0–1*	0–1*	0.8*	0.17*			
Auto-Continuum 500	(907657) EtherNet/IP™	20–600 A, 10–44 V	500 A at 39 VDC, 100% duty cycle	IP23	58.7	34.9	33.2	28.9	23.3	23.1	21.9	75 VDC		69 kg (150 lb.)
	(907659) EtherNet/IP™ with auxiliary power (907661) EtherNet/IP™, CE				0–1*	0–1*	0–1*	0–1*	0–1*	0.8*	0.17*			
Auto-Continuum Wire Drive Motor Assembly (301207) Left-hand drive, CE (301208) Right-hand drive, CE		Input Power	Input Welding Circuit Rating	IP Rating	Wire Feed Speed		Wire Diameter Capacity		Dimensions		Net Weight			
		50 VDC	500 A at 100% duty cycle	IP23	Standard: 1.3–25.4 m/min. (50–1,000 ipm)		0.9–2.0 mm (.035–5/64 in.)		H: 222 mm (8.75 in.) W: 254 mm (10 in.) D: 254 mm (10 in.)		7.5 kg (16.5 lb.)			

Engineered for simplicity. Built for durability.

Your welders select the Bernard gun handles, triggers and necks that are **the most comfortable and effective** for accessing their welds.

Management enjoys the resulting **increase in productivity, longer gun life, and a reduced parts inventory** with consumables designed to work across all of your welding guns.

BERNARD[®]
BERNARD



Visit the **NEW! merged website** for
Bernard and Tregaskiss at Tregaskiss.com

1-855-MIGWELD (644-9353)

Maximizing throughput. Minimizing costs.

Automated welding applications require flexible, repeatable solutions that **maximize production uptime and throughput while minimizing costs**. This is why industrial manufacturers rely on Tregaskiss and its proven track record of delivering **reliable and resilient robotic and fixed automatic MIG welding guns, peripherals and consumables**.

 **Tregaskiss**[®]





For more detailed information, visit

MillerWelds.com/wirefeeders

Wire Feeders

Also see MIG, MIG Guns and Multiprocess sections for wire feeding options.



Product Guide

	Class	MIG	Pulsed MIG ¹	RMP ¹	Flux-cored ²	Power Source Required	Wire Types				Wire Diameter Capacity	Special Features	Typical Applications	
							Hard	Flux-cored Dual-shld	Self-shld	Alum.				
ArcReach® SuitCase® 8/12	●	●	○		●	CC/CV	●	●	● CV ²	○	0.6-2.0 mm (.023-5/64 in.)	8 in. (SuitCase 8) or 12 in. (SuitCase 12) diameter spool capacity, remote voltage control without a control cord, powered by arc voltage	Construction, site fabrication, field maintenance	Portable
ArcReach® Smart Feeder	●	●	●	●	○	ArcReach equipped	●	●			0.9-1.1 mm (.035-.045 in.)	12 in. diameter spool capacity, remote voltage control without a control cord, requires an XMT 350 FieldPro connected to three-phase power or an ArcReach-equipped engine drive	Process piping, refinery, petrochemical, power plants, HVAC, water pipe	
SuitCase® 12RC	●	●	○		●	CV	●	●	●	○	0.6-2.0 mm (.023-5/64 in.)	12 in. diameter spool capacity, standard remote voltage control, powered by 14-pin control cord	Field maintenance, site fabrication	
20 Series (Basic and Digital)	●	●	○		●	CV	●	●	●	○	0.6-2.0 mm (.023-5/64 in.)	Four quick-change drive rolls, digital meters, remote voltage control (meters and remote voltage control are a field kit option on basic model)	Manufacturing, fabrication	Bench
70 Series (74S/74D) Singles and Duals	●	●	○		●	CV	●	●	●	○	0.6-3.2 mm (.023-1/8 in.) Low-speed motor recommended for 3/32 and 1/8 in. wires	Four quick-change drive rolls, digital meters, remote voltage control (meters and remote voltage control are a field kit option on 74S models)	Heavy and light manufacturing, fabrication	
70 Series (74 MPa Plus) Singles and Duals	●	●	●		●	CV	●	●	●	●	0.6-2.0 mm (.023-5/64 in.)	XR-Aluma-Pro™ Plus or XR™-Pistol Plus guns for feeding soft wires	Manufacturing requiring multiple wire types	
70 Series Swingarc™ Singles and Duals	●	●	○		●	CV	●	●	●	● ³	0.6-2.0 mm (.023-5/64 in.)	8, 12 and 16 ft. booms, four drive rolls, adjustable weld control	Heavy and light manufacturing, fabrication	
70 Series Remote Configurations Singles and Duals	●	●	○		●	CV	●	●	●	● ³	0.6-2.0 mm (.023-5/64 in.)	Control box, cables and wire drive motor assemblies for generic booms or fixed automation	Heavy and light manufacturing, fabrication	

Product Key

Class: ● Light industrial ● Industrial ● Heavy industrial Capability: ● Designed for this process ○ Capable of this process

¹ Smart Feeder requires an XMT® 350 FieldPro™ connected to three-phase power or an ArcReach-equipped engine drive. All other feeders require an MPa inverter power source.

² Certain self-shielded wires require CV output. Miller recommends a CV power source whenever possible.

³ 74S and 74D models are capable of aluminum welding. 74 MPa Plus models are designed for aluminum welding.

SuitCase® Series Portable Feeders

Portable SuitCase feeders that set the standard for performance and provide extreme reliability to stand up to the demands of construction and fabrication.



SuitCase Series Features

Feature	ArcReach			12RC
	8	12	Smart	
Remote voltage control (control cord required)				●
Remote voltage control (without a cord)	●	●	●	
Digital meters	●	●	●	●
Impact-resistant case	●	●	●	●
Gas purge	●	●	●	●
Wire jog	●	●	●	●
● Standard				

Note: ArcReach SuitCase feeders are compatible with standard power sources and engine-driven welders, but function as standard equipment without remote control capabilities. Full functionality of ArcReach is only available with ArcReach power sources.

Setting the standard for performance

Heavy-duty drive motor with tachometer control provides wire feed speed that is accurate and consistent from the start of the weld to the finish and from one weld to the next. Consistent wire feed speed is very important with large-diameter cored wire, because small changes in wire feed speed make large changes in deposition rates.

Wide voltage range for small and large wires with no contactor chatter or arc outages.



Ultra-low drag inlet guide pins make loading the wire easy and does not deform the wire on the way into the drive rolls improving wire feeding performance.



Scaled wire pressure knob provides easy adjustment and consistent pressure on the drive rolls and wire.



Digital meters with SunVision™ technology can display voltage, wire feed speed, and also amperage if desired. Meters can be seen clearly even in direct sunlight.

Unique and durable case

Impact-resistant, flame-retardant case provides strength and durability, and protects components and welding wire from moisture, dust and other contaminants.

Built-in slide rails allow you to drag the feeder into position for welding.

Innovative feeder door design allows you can change wire while feeder is standing upright or laying down.

Extreme reliability

Potted and trayed main printed circuit board for the harshest environments adds exceptional reliability. Board has full-trigger isolation so a shorted gun trigger will not affect feeder operation.



Gun locking tab works with guns and Euro-adaptor having corresponding locking grooves to prevent gun from being pulled out if the feeder is dragged by the gun.



Gas inlet recessed into back of case is protected from incidental contact by the weld cable, ensuring consistent and contaminant-free shielding gas delivery to the gun. **Double-filtered gas valve** helps keep dirt from clogging and affecting gas flow.

ArcReach® SuitCase® 8 and 12 and ArcReach Smart Feeder

See literature M/6.55

ArcReach Remote control of the power source without a cord. With a ArcReach SuitCase feeder and ArcReach power source you can change output voltage at the feeder, and save a trip to the power supply. No extra control cable to purchase, maintain, string or unstring – saving time and money.

Easy process changeover. Simply connect the ArcReach feeder to your leads and you are ready to go. All controls automatically shift to the ArcReach feeder.

Voltage-sensing feeders designed to run off of arc voltage. The ArcReach SuitCase 8 and 12 operate on the arc voltage of almost any power source. The ArcReach Smart Feeder requires an XMT® 350 FieldPro™ connected to three-phase power or an ArcReach-equipped engine drive.

Additional features of ArcReach Smart Feeder

Delivers excellent synergic RMD® and pulsed MIG welding up to 61 meters (200 ft.) away from the power source with no control cords – twice the distance previously possible. RMD and pulsed MIG welding permits procedures with one wire and one gas to eliminate process switch-over time. RMD and pulsed MIG processes also help reduce weld failures and eliminate backing gas on some stainless and chrome-moly applications.



Heavy industrial

Use with CC/CV (CV only with 12RC), DC power sources. See spec chart below for Smart Feeder requirements.

Processes

- MIG (GMAW) ▪ Flux-cored (FCAW)
- RMD and pulsed MIG (GMAW-P) with ArcReach Smart Feeder

Suggested power sources

Note: ArcReach SuitCase feeders are compatible with standard power sources and engine-driven welders, but function as standard equipment without remote control capabilities. Full functionality of ArcReach is only available with ArcReach power sources.

For ArcReach SuitCase 8 and 12

- Dynasty® 280 DX Multiprocess
- Dimension™ 650/650 ArcReach®
- XMT® Series
- Bobcat™ Series
- Trailblazer® Series
- Big Blue® Series

For ArcReach Smart Feeder

- XMT® 350 FieldPro (requires three-phase power)
- Trailblazer® Series (ArcReach models only)
- Big Blue® Series (ArcReach models only)

For SuitCase 12RC (requires power source with 14-pin connector)

- Dimension™ 650
- XMT® Series
- Bobcat™ Series
- Trailblazer® Series
- Big Blue® Series

Suggested guns

- Bernard® Guns

Most popular accessories

- Extension Cables (for SuitCase 12RC only, 1 required)
- Flowmeter Kit 300343
- Shielding Gas Filter 195189
- Dinse 70 Series
134460 Male
136600 Female

SuitCase® 12RC See literature M/6.5

Standard remote voltage control with a control cord. For applications where the feeder is within 30.5 meters (100 ft.) of the power source and control cords are acceptable. Requires power source with 14-pin connector.

	Model/Stock Number	Input Power	IP Rating	Input Welding Circuit Rating	Wire Feed Speed	Wire Type and Diameter Capacity	Maximum Spool Size Capacity	Dimensions	Net Weight
ArcReach	ArcReach Suitcase 8 (301457) Tweco®, CE	Operates on open-circuit voltage and arc voltage: 14-48 VDC/110 max. OCV	IP23	330 A at 60% duty cycle	1.3-19.8 mpm (50-780 ipm) Actual range in CC mode is dependent on arc voltage applied	Solid wire 0.6-1.4 mm (.023-.052 in.) Flux-cored 0.8-2.0 mm (.030-5/64 in.)	203 mm (8 in.), 6.4 kg (14 lb.)	H: 324 mm (12.75 in.) W: 184 mm (7.25 in.) D: 457 mm (18 in.)	13 kg (28 lb.)
	425 A at 60% duty cycle								
	ArcReach Suitcase 12 (301456) Tweco®, CE					Solid wire 0.6-1.4 mm (.023-.052 in.) Flux-cored 0.8-2.0 mm (.030-5/64 in.)	305 mm (12 in.), 20 kg (45 lb.)	H: 394 mm (15.5 in.) W: 229 mm (9 in.) D: 533 mm (21 in.)	15.9 kg (35 lb.)
	ArcReach Smart Feeder (301177) Dinse, CE (300935) Tweco® (300935002) Tweco® w/flowmeter	XMT 350 FieldPro or PipeWorx 350 FieldPro connected to three-phase power or an ArcReach-equipped engine drive	IP23	275 A at 60% duty cycle	1.3-19.8 mpm (50-780 ipm) dependent on arc voltage	0.9-1.1 mm (.035-.045 in.)	305 mm (12 in.), 15 kg (33 lb.)	H: 457 mm (18 in.) W: 330 mm (13 in.) D: 546 mm (21.5 in.)	23 kg (50 lb.)
	SuitCase 12RC (301121) Tweco®, CE	24 VAC, 10 A, 50/60 Hz	IP23	425 A at 60% duty cycle	1.3-17.8 mpm (50-700 ipm)	Solid wire 0.6-1.4 mm (.023-.052 in.) Flux-cored 0.8-2.0 mm (.030-5/64 in.)	305 mm (12 in.), 20 kg (45 lb.)	H: 394 mm (15.5 in.) W: 229 mm (9 in.) D: 533 mm (21 in.)	14.1 kg (31 lb.)

20 Series Industrial Bench Feeders

70 Series Heavy-Industrial Bench Feeders

Designed for manufacturing, our popular bench feeders are available in two series with multiple models to fit your needs.



20 Series Digital

S-74D

S-74 MPa Plus

D-74 MPa Plus

Feeders include a 3 m (10 ft.) interconnecting cord.

20 and 70 Series Features

Feature	20 Series		70 Series		
	Basic	Digital	74S	74D	74MPA
Trigger hold	●	●	●	●	●
Adjustable run-in control	● ¹	●	●	●	●
Automatic run-in control			●	●	●
Digital meter(s)	● ¹	●	● ¹	●	●
Remote voltage control	● ¹	●	● ¹	●	●
Preflow/postflow			●	●	●
Spot control			●	●	●
Dual-wire models			●	●	●
Rotatable drive assembly			●	●	●
Accu-Mate™					●
Dual schedule control					●
Trigger program select					●
Trigger dual schedule					●
Sequence control					●
Locks and limits					●
Weld programs					4
Trigger schedule select					●
Push-pull capability					●
Synergic pulsed MIG					●
Profile Pulse™					●

● Standard ● Optional ¹Field option.

Trigger hold allows the operator to make long welds without having to hold the trigger continuously. Reduces operator fatigue.

Miller® standard, quick-change drive rolls save time.

Quick-release drive-roll pressure arm allows drive roll change without losing spring preload setting.

Easy loading and threading of welding wire without having to release the drive roll pressure arm.

Four gear-driven drive rolls provide more consistent feeding on larger wire diameters.

Feeders include a 3 m (10 ft.) 14-pin interconnecting cord.

Additional features for 70 Series feeders

Available in dual-wire models which allows two different wire types to be available on one feeder, avoiding downtime from changing spools and drive rolls.

Toolless rotatable drive assembly allows operator to rotate the drive housing, allowing a straight path for wire flow.

High-torque permanent-magnet motor, sealed ball bearing gear drive and solid-state speed and brake control are maintenance free for long life.

20 Series (Basic and Digital) See literature M/11.0

Simple and cost-effective feeders for industrial manufacturing and fabricating.

Ideal for most high-duty-cycle applications requiring day-in/day-out trouble-free operation.

On-board burnback and motor ramp control for excellent starting and stopping performance.

Digital meter (standard on digital model, field option on basic model) ensures accuracy when presetting and reading actual voltage, amperage and wire feed speed.

Remote voltage control (standard on digital model, field option on basic model) at feeder for easier adjustments in the weld cell.

Adjustable run-in control (standard on digital model, field option on basic model) for better arc-starting performance on a variety of wires.

70 Series (74S and 74D) See literature M/3.0

Standard, simple feeders for most heavy-industrial applications, with the 74D providing increased accuracy and control of the most common weld parameters.

Digital meters (74D models only) ensure accuracy when presetting and reading actual voltage, amperage and wire feed speed.

Remote voltage control (74D models only) allows you to set both voltage and wire feed speed at the feeder, saving time and increasing weld quality because optimal weld parameters are easy to set.

70 Series (74 MPa Plus) See literature M/3.0

Adds features for weld control and programs, plus push-pull aluminum capabilities. Optimized with Invision™ MPa or XMT® MPa power sources.

Adjustable run-in control for improved arc starts.

Dual schedule control allows the operator to switch between two preconfigured welding parameters without readjusting the machine, saving time and enhancing quality.

Trigger schedule select saves time when switching between two weld settings by simply tapping gun trigger.

Trigger program select provides the ability to access any of the four active programs.

Sequence control gives the operator the ability to adjust all of the welding parameters: preflow, run-in, weld time, crater, burnback and postflow.

Locks and limits for restricting or limiting operator adjustments, such as voltage and wire feed speed parameters.

Four weld program memories allow operators to recall up to four previously used processes and their weld settings.

Accu-Mate™ properly seats the MIG gun power pin for best feeding performance.

Push-pull capability provides consistent, versatile and dependable aluminum wire feeding over greater distances.

Recommended aluminum solution.

Dedicated XR Plus guns (gooseneck and pistol grip) work with MPa Plus feeders to coordinate wire feed speed of the gun and the feeder. This provides optimized aluminum feeding and welding performance. See chart below for gun models and stock numbers.



Additional features when used with Invision MPa or XMT MPa power sources

Synergic pulsed MIG. As wire speed increases/decreases, pulse parameters also increase/decrease to match the right amount of power needed, eliminating the need to make additional adjustments.

Profile Pulse™ provides TIG appearance with MIG simplicity and productivity. Achieve “stacked dimes” without gun manipulation. Profile Pulse frequency can be changed to increase or decrease the spacing between the ripple pattern to achieve the desired weld appearance.



Industrial ● 20 Series
Heavy industrial ● 70 Series

CVDC Use with CV, DC power sources.

Processes

- MIG (GMAW) ▪ Flux-cored (FCAW)
- Pulsed MIG (GMAW-P) with MPa Plus feeder and optional MPa power source

Suggested power sources

- Invision™ MPa Series
- Dimension™ 650/650 ArcReach®
- XMT® Series

Suggested guns

- Bernard™ Guns
- XR-Aluma-Pro™ Plus and XR™-Pistol Plus (see chart below)

Most popular accessories

- Wire Straightener
- Hanging Bail 058435
- Wire Reel Assembly 108008
- Spool Covers
 - 057607 For 20 and 70 Series single-wire models and left side of dual-wire models
 - 090389 For right side of dual-wire models
- 1.0 mm Drive Roll
 - 4 - 053696
 - 1 - 056192
 - 1 - 056206

*Requires wire kit (230708) to run 1.6 mm (1/16 in.) wire.

Model	Stock Number	Input Power	Wire Feed Speed	Wire Type and Diameter Capacity	Maximum Spool Size Capacity	Dimensions	Net Weight	
20 Series	Basic (301499), CE Digital (301499001), CE	24 VAC, 3.5 A, 50/60 Hz	1.9–19 m/min. (75–750 ipm)	0.6–2.0 mm (.023–5/64 in.)	27 kg (60 lb.) coil with optional wire reel assembly (108008)	H: 406 mm (16 in.) W: 314 mm (12.375 in.) D: 708 mm (27.875 in.)	21 kg (46 lb.)	
70 Series (Single-wire models)	S-74S (300616), CE S-74D (300617), CE S-74D (300617001) w/high speed motor, CE S-74 MPa Plus (300577), CE	24 VAC, 10 A, 50/60 Hz	1.3–19.8 m/min. (50–780 ipm)	0.6–3.2 mm (.023–1/8 in.) Low-speed motor recommended for 2.4 and 3.2 mm (3/32 and 1/8 in.) wires (factory option) MPa Plus model Hard wire 0.6–2.0 mm (.023–5/64 in.) Aluminum* 0.9–1.6 mm (.035–1/16 in.)	7 kg (60 lb.) coil with optional wire reel assembly (108008)	H: 356 mm (14 in.) W: 318 mm (12.5 in.) D: 711 mm (28 in.)	26 kg (58 lb.)	
70 Series (Dual-wire models)	D-74S (300619), CE D-74D (300620), CE D-74 MPa Plus (300578), CE					H: 356 mm (14 in.) W: 533 mm (21 in.) D: 889 mm (35 in.)	39.5 kg (87 lb.)	
Optional Push-Pull Gun <i>(For MPa Plus feeders only)</i>		Cable Length		Welding Current Rating	Wire Feed Speed	Wire Type and Diameter Capacity	Dimensions	Net Weight
	4.6 m (15 ft.)	7.6 m (25 ft.)	10.6 m (35 ft.)					
XR-Aluma-Pro Plus (Air-cooled)	(301575)	(301574)	–	300 A at 100% duty cycle	1.8–23 m/min. (70–900 ipm)	Aluminum* 0.8–1.6 mm (.030–1/16 in.)	H: 127 mm (5 in.) W: 64 mm (2.5 in.) L: 432 mm (17 in.)	1.1 kg (2.5 lb.)
XR-Aluma-Pro Plus (Water-cooled)	(301576), CE	(301577), CE	–	400 A at 100% duty cycle			L: 432 mm (17 in.)	1.3 kg (2.9 lb.)
XR-Pistol Plus (Air-cooled)	(300753)	(300754)	–	200 A at 100% duty cycle	1.8–23 m/min. (70–900 ipm)	Aluminum* 0.8–1.6 mm (.030–1/16 in.)	H: 187 mm (7.375 in.) W: 48 mm (1.875 in.)	1 kg (2.2 lb.)
XR-Pistol Plus (Water-cooled)	–	(300757)	–	400 A at 100% duty cycle			L: 270 mm (10.625 in.)	1.1 kg (2.4 lb.)

70 Series Remote Configurations

See literature M/3.0

Remote wire feeder control box and wire drive assembly for non-Miller boom applications.



S-74 MPa Plus shown.

Note: MPa Plus wire drive motor assemblies and control cables are only for use with MPa Plus control boxes.

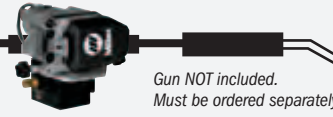

Gun NOT included. Must be ordered separately.

Single-wire control box
300881 S-74S, CE
300882 S-74D, CE
300738001 S-74 MPa Plus, CE

Motor control cable
 Standard: 11 conductor
 MPa Plus: 14 conductor

Wire drive motor assembly
300904 Standard left-hand drive, CE
300740001 MPa Plus left-hand drive, CE
 MPa Plus drive can be used with push-only guns, or XR-Aluma-Pro™ Plus and Pistol Plus push-pull guns.

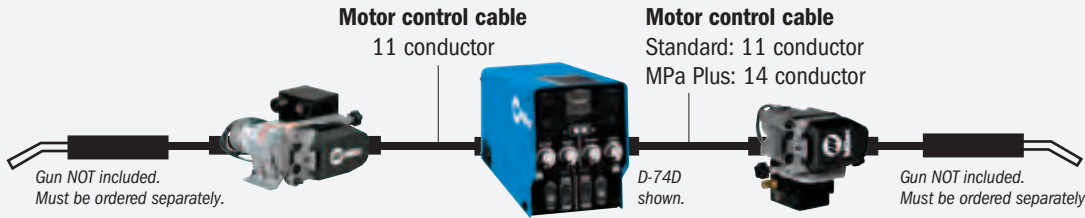

Push-only wire drive motor assembly
300741001 Standard right-hand drive, CE
300741 MPa Plus right-hand drive, CE

Dual-wire control box
300886 D-74S, CE
300887 D-74D, CE
300739 D-74 MPa Plus, CE

Wire drive motor assembly
300904 Standard left-hand drive, CE
300740001 MPa Plus left-hand drive, CE
 MPa Plus drive can be used with push-only guns, OR XR-Aluma-Pro™ Plus and Pistol Plus push-pull guns.

Heavy industrial CV DC

Use with CV, DC power sources.

Processes

- MIG (GMAW) • Flux-cored (FCAW)
- Pulsed MIG (GMAW-P) with MPa Plus control box and optional MPa power source

Suggested power sources/guns

- Same as 70 Series

Most popular accessories

- Motor Control Cable (11 conductor)
 254935010 3 m (10 ft.)
 254935025 7.6 m (25 ft.)
 For push-only gun configurations.
- MPa Plus Motor Control Cable (14 conductor)
 254864010 3 m (10 ft.)
 254864025 7.6 m (25 ft.)
 For MPa Plus configurations only – single-wire or left side of dual-wire.



- **Feeder Base** 195369
 For use with spooled wire.

70 Series Swingarc™

See literature M/13.11

Swingarc boom-mounted wire feeders bring an extra dimension of flexibility and efficiency to weld stations dealing with large weldments, or wherever operator mobility is required.

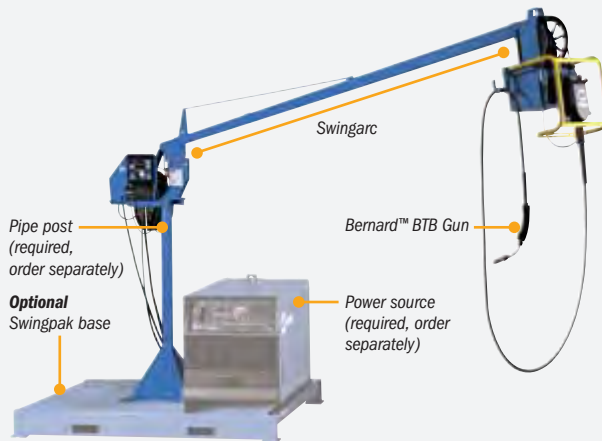

Models in 2.4 m (8 ft), 3.6 m (12 ft) or 4.8 m (16 ft) lengths maximize output.

Counterbalance design makes it easy to position boom and 360-degree rotation and 60-degree lift angle maximizes work area.

In-boom cable routing organizes hoses and cables for a cleaner work environment.

Standard 3 m (10 ft) 14-pin interconnecting cord included.

MPa Plus Swingarcs. Optimized for the Invision™ MPa and XMT® MPa power sources and available with single- or dual-wire feeders and three boom lengths.

Heavy industrial CV DC

Use with CV, DC power sources.

Processes

- MIG (GMAW) • Flux-cored (FCAW)
- Pulsed MIG (GMAW-P) with MPa Plus feeder and optional MPa power source

Suggested power sources/guns

- Same as 70 Series

Most popular accessories

- Swingpak™ Base 183997
- Pipe Post with 45 mm (1.8 in.) Base
 149838 1.2 m (4 ft.)
 149839 1.8 m (6 ft.)
- **Single/Dual Spool Carrier** (pipe post not included)
 300353 For 1.2 m (4 ft.) post
 300352 For 1.8 m (6 ft.) post
 Designed to put spool hub assembly at 914 mm (36 in.) from base for easier wire spool installation.

		Model/Stock Number			
Single-Wire Feeder Models	Boom Size	Feeder Control Box	Dual-Wire Feeder Models	Boom Size	Feeder Control Box
SS-74S8	2.4 m (8 ft.) (300518)	S-74S (300881), CE	DS-74S8	2.4 m (8 ft.) (300521)	D-74S (300886), CE
SS-74D8	2.4 m (8 ft.) (300518)	S-74D (300882), CE	DS-74D8	2.4 m (8 ft.) (300521)	D-74D (300887), CE
SS-74DX8	2.4 m (8 ft.) (300518)	S-74MPa Plus (300738), CE	DS-74DX8	2.4 m (8 ft.) (300521)	D-74MPa Plus (300739), CE
SS-74MPa Plus-8	2.4 m (8 ft.) (300818)		DS-74MPa Plus-8	2.4 m (8 ft.) (300821)	
SS-74S12	3.7 m (12 ft.) (300519)	S-74S (300881), CE	DS-74S12	3.7 m (12 ft.) (300522)	D-74S (300886), CE
SS-74D12	3.7 m (12 ft.) (300519)	S-74D (300882), CE	DS-74D12	3.7 m (12 ft.) (300522)	D-74D (300887), CE
SS-74DX12	3.7 m (12 ft.) (300519)	S-74MPa Plus (300738), CE	DS-74DX12	3.7 m (12 ft.) (300522)	D-74MPa Plus (300739), CE
SS-74MPa Plus-12	3.7 m (12 ft.) (300819)		DS-74MPa Plus-12	3.7 m (12 ft.) (300822)	
SS-74S16	4.9 m (16 ft.) (300520)	S-74S (300881), CE	DS-74S16	4.9 m (16 ft.) (300523)	D-74S (300886), CE
SS-74D16	4.9 m (16 ft.) (300520)	S-74D (300882), CE	DS-74D16	4.9 m (16 ft.) (300523)	D-74D (300887), CE
SS-74DX16	4.9 m (16 ft.) (300520)	S-74MPa Plus (300738), CE	DS-74DX16	4.9 m (16 ft.) (300523)	D-74MPa Plus (300739), CE
SS-74MPa Plus-16	4.9 m (16 ft.) (300820)		DS-74MPa Plus-16	4.9 m (16 ft.) (300823)	
Input Power	Wire Speed	Wire Diameter Capacity		Maximum Spool Size Capacity	
24 VAC, 10 A, 50/60 Hz	1.3 - 19.8 m/min. (50-780 IPM) Optional High Speed: 2.3 - 36.6 m/min. (92-1435 IPM)	Standard Speed Motor: 0.6 - 3.2 mm (.023 - 1/8 in.) When using 2.4 - 3.2 mm (3/32 - 1/8 in.) wires, consult factory for low speed options.		27 kg (60 lb.) coil	



For more detailed information, visit

MillerWelds.com/guns-torches

Product Guide

	Class	Wire Types				Wire Types			Wire Diameter Capacity	Available Cable Lengths	Typical Applications	
		MIG	Pulsed MIG	Flux-cored*	Solid	Flux-cored		Alum.				
						Dual-shld	Self-shld					
MIGmatic™ M-100 MIG Gun	●	●	●	●	●	●	●	●	0.6-1.2 mm (.023-.045 in.)	10 ft.	Light industrial steel fabrication	Steel
MIGmatic™ M-150 MIG Guns	●	●	●	●	●	●	●	●	0.6-1.2 mm (.023-.045 in.)	15 ft.	Light industrial steel fabrication	
MDX™-100 MIG Gun	●	●	●	●	●	●	●	●	0.6-1.2 mm (.023-.045 in.)	10 ft.	Light industrial steel fabrication	
MDX™-250 MIG Guns	●	●	●	●	●	●	●	●	0.6-1.2 mm (.023-.045 in.)	10, 12 or 15 ft.	Industrial steel fabrication	
MDX™-250 EZ-Select™ MIG Guns	●	●	●	●	●	●	●	●	0.6-1.2 mm (.023-.045 in.)	15 ft.	Industrial steel fabrication	
Bernard® BTB MIG Guns	●	●	●	●	●	●	●	●	0.6-3.2 mm (.023-1/8 in.)	10, 15, 20, or 25 ft.	Heavy industrial steel fabrication	
Bernard® Clean Air™ Fume Extraction Guns with Straight Handle	●	●	●	●	●	●	●	●	0.6-3.2 mm (.023-1/8 in.)	8, 10, 12, 15, 20, or 25 ft.	Heavy industrial steel fabrication	
Bernard® Clean Air™ Fume Extraction Guns with Curved Handle	●	●	●	●	●	●	●	●	0.6-2.0 mm (.023-5/64 in.)	8, 10, 12, 15, 20, or 25 ft.	Heavy industrial steel fabrication	
Bernard® Dura-Flux™ Guns with Fixed Liner	●	●	●	●	●	●	●	●	1.6-2.4 mm (1/16-3/32 in.)	8, 10, 12, 15, 20, or 25 ft.	Heavy industrial steel fabrication	
Bernard® Dura-Flux™ Guns with Replaceable Liner	●	●	●	●	●	●	●	●	1.2-2.0 mm (.045-5/64 in.)	8, 10, 12, 15, 20, or 25 ft.	Heavy industrial steel fabrication	
Spoolmate™ Spool Guns	●	●	●	●	●	●	●	●	100/200/3035 models: 0.6-0.9 mm (.023-.035 in.) 150 model: 0.8-0.9 mm (.030-.035 in.)	100 model: 12 ft. 150/200/3035 models: 20 ft.	Light industrial aluminum fabrication	Aluminum
Spoolmatic® Spool Guns	●	●	●	●	●	●	●	●	0.8-1.6 mm (.030-1/16 in.)	15 or 30 ft.	Industrial aluminum fabrication	
XR-Aluma-Pro™ Lite Push-Pull Gun	●	●	●	●	●	●	●	●	0.8-1.2 mm (.030-.047 in.)	25 ft.	Industrial aluminum fabrication	
XR-Aluma-Pro™ Push-Pull Guns	●	●	●	●	●	●	●	●	0.8-1.6 mm (.030-1/16 in.)	15, 25 or 35 ft.	Heavy industrial aluminum fabrication	
XR™ Pistol Push-Pull Guns	●	●	●	●	●	●	●	●	0.8-1.6 mm (.030-1/16 in.)	XR-Pistol: 15 or 30 ft. XR-Pistol-Pro: 15, 25 or 35 ft.	Heavy industrial aluminum fabrication	

Product Key Class: ● Light industrial ● Industrial ● Heavy industrial Capability: ● Designed for this process ● Capable of this process

*Certain self-shielded wires require CV output. Miller recommends a CV power source whenever possible.

MIGmatic™ M-Series MIG Guns See literature AY/15.0

Upgrade your M-100 and M-150 MIG guns to AccuLock™ MDX™ consumables with a conversion diffuser.



AccuLock™ MDX™ Conversion Kit 1880269

Kit features a conversion diffuser to consolidate MIG nozzles and contact tips to AccuLock MDX. Includes diffuser (1070115), 12.7 mm (1/2 in.) flush nozzle (NS-M1200C), five 0.8 mm (.030 in.) contact tips (T-M030), five 0.9 mm (.035 in.) contact tips (T-M035) and a consumables storage box.

Light Industrial ●

Processes

- MIG (GMAW) ▪ Flux-cored (FCAW)

Suggested power sources

- Millermatic® 141/211 (M-100/M-150)
- Multimatic® 200 (M-150)
- Multimatic® 215 (M-100/M-150)
- Multimatic® 220 (M-100/M-150)

Most popular accessories

- MIGmatic M-Series Consumable Kits
234607 0.6 mm (.023 in.)
234608 0.8 mm (.030 in.)
234609 0.9 mm (.035 in.)
- AccuLock™ MDX™ Conversion Kit 1880269
Allows MIGmatic M-100 and M-150 MIG guns to upgrade to AccuLock™ MDX™ nozzles and tips

Model	Stock Number	Cable Length	Rated Output	Rated Duty Cycle	Wire Diameter Capacity	Gun Only Net Weight
M-100	(248282)	3 m (10 ft.)	100 A	100% with CO ₂ gas, 60% with mixed gas	0.6-1.2 mm (.023-.045 in.)	1.5 kg (3.2 lb.)
M-150	(249041)	4.6 m (15 ft.)	150 A	100% with CO ₂ gas, 60% with mixed gas	0.6-1.2 mm (.023-.045 in.)	2.7 kg (6.0 lb.)

MDX™ Series MIG Guns

See literature AY/15.5

An ideal match for Miller® all-in-one MIG machines or other Miller wire feeders.



Durable, ergonomic handle features rubber overmolding for improved grip and rear swivel to reduce welder fatigue.

AccuLock™ consumables provide long life and superior wire feeding. See below for more information.

Pulse welding capable due to increased copper in the gun cable which ensures reliable performance with CV and pulse waveforms (MDX-250/MDX-250 EZ-Select only).

EZ-Select™ function allows you to conveniently select from up to four weld programs by tapping the MIG gun trigger rather than walking back to the machine. Lights on handle indicate weld program selected (MDX-250 EZ-Select only).



Model	Stock Number	Cable Length	Rated Output	Rated Duty Cycle	Standard Wire Size	Standard Consumables
MDX-100	(1770028)	3 m (10 ft.)	100 A	100% with CO ₂ gas, 60% with mixed gas	0.8–0.9 mm (.030–.035 in.)	AccuLock MDX
MDX-250	(1770035)	3 m (10 ft.)	250 A	100% with CO ₂ gas, 60% with mixed gas	0.8–0.9 mm (.030–.035 in.)	AccuLock MDX
	(1770036)	3.7 m (12 ft.)	250 A	100% with CO ₂ gas, 60% with mixed gas	0.8–0.9 mm (.030–.035 in.)	AccuLock MDX
	(1770037)	4.6 m (15 ft.)	250 A	100% with CO ₂ gas, 60% with mixed gas	0.8–0.9 mm (.030–.035 in.)	AccuLock MDX
	(1770038)	4.6 m (15 ft.)	250 A	100% with CO ₂ gas, 60% with mixed gas	0.9–1.2 mm (.035–.045 in.)	AccuLock MDX
	(1770041)	3 m (10 ft.)	250 A	100% with CO ₂ gas, 60% with mixed gas	0.9–1.2 mm (.035–.045 in.)	AccuLock S
	(1770042)	3.7 m (12 ft.)	250 A	100% with CO ₂ gas, 60% with mixed gas	0.9–1.2 mm (.035–.045 in.)	AccuLock S
MDX-250 EZ-Select	(1770046)	4.6 m (15 ft.)	250 A	100% with CO ₂ gas, 60% with mixed gas	0.9–1.2 mm (.035–.045 in.)	AccuLock S
	(1770047)	4.6 m (15 ft.)	250 A	100% with CO ₂ gas, 60% with mixed gas	0.8–0.9 mm (.030–.035 in.)	AccuLock MDX

AccuLock™ MDX™ Consumables

See literature AY/15.5

Flawless wire feeding path. Front-loading liner is locked and concentrically aligned with both the contact tip and power pin.

Error-proof liner trimming ensures accurate replacement every time – no measuring required!

Maximize electrical conductivity and tip life. Tapered mating surface between the contact tip and gas diffuser locks tips in place for optimal performance.

Upgrade to AccuLock S consumables for increased durability and longer life when guns are used in pulsed welding or more industrial applications.



MDX Series MIG Guns Consumable Kits



For MDX-100 with AccuLock MDX

- 1880272** 0.6 mm (.023 in)
- 1880273** 0.8 mm (.030 in)
- 1880274** 0.9 mm (.035 in)

For MDX-250 with AccuLock MDX

- 1880275** 0.8 mm (.030 in)
- 1880276** 0.9 mm (.035 in)
- 1880277** 1.2 mm (.045 in)

For MDX-250 with AccuLock S

- 1880278** 0.9 mm (.035 in)
- 1880279** 1.2 mm (.045 in)

Kits include ten contact tips, one nozzle, one diffuser, and a consumable storage box. Both kits for MDX-250 gun also include one neck insulator.

Light industrial ● MDX-100
Industrial ● MDX-250/250 EZ-Select

Processes

- MIG (GMAW) ■ Flux-cored (FCAW)
- Pulsed MIG (GMAW-P) with MDX-250/250 EZ-Select

Suggested power sources

For MDX-100

- Millermatic® 141/211
- Multimatic® 215
- Multimatic® 220 AC/DC

For MDX-250

- Millermatic® 252
- Millermatic® 255
- Multimatic® 200
- Multimatic® 235
- Multimatic® 255

For MDX-250 EZ-Select

- Millermatic® 255
- Millermatic® 355
- Multimatic® 255

Most popular consumables

AccuLock Consumables

Liners

- LM1A-10** 0.6 mm, 3.0 m length
- LM2A-10** 0.8–0.9 mm, 3.0 m length
- LM3A-10** 0.9–1.2 mm, 3.0 m length
- LM1A-12** 0.6, 3.0 mm, 3.7 m length
- LM2A-12** 0.8–0.9 mm, 3.7 m length
- LM3A-12** 0.9–1.2 mm, 3.7 m length
- LM1A-15** 0.6, 3.0 mm, 4.6 m length
- LM2A-15** 0.8–0.9 mm, 4.6 m length
- LM3A-15** 0.9–1.2 mm, 4.6 m length

Diffusers

- D-M100** MDX-100
- D-M250** MDX-250
- D-MA250M** MDX-250 AccuLock S conversion

MDX-100 Nozzles (mm)

- NS-M1200B** 12.7 ID, flush, brass
- NS-M1200C** 12.7 ID, flush, copper
- NS-MFLX** Gasless nozzle

MDX-250 Nozzles (mm)

AccuLock MDX

- N-M1200C** 12.7 ID, flush, copper
- N-M1218C** 12.7 ID, 3.2 rec., copper
- N-M5800C** 15.9 ID, flush, copper
- N-M5818C** 15.9 ID, 3.2 rec., copper
- N-M58XTC** 15.9 ID, 3.2 ext., copper

AccuLock S

- N-A5800CM** 15.9 ID, flush, copper
- N-A5818CM** 15.9 ID, 3.2 rec., copper
- N-A5814CM** 15.9 ID, 6.4 rec., copper

Contact Tips

AccuLock MDX

- T-M023** 0.6 mm (.023 in.)
- T-M030** 0.8 mm (.030 in.)
- T-M035** 0.9 mm (.035 in.)
- T-M045** 1.2 mm (.045 in.)
- T-M047** 1.2 mm (3/64 in.)

AccuLock S

- T-A023CHM** 0.6 mm (.023 in.)
- T-A030CHM** 0.8 mm (.030 in.)
- T-A035CHM** 0.9 mm (.035 in.)
- T-A039CHM** 1.0 mm (.039 in.)
- T-A045CHM** 1.2 mm (.045 in.)

Spoolmate™ Spool Guns

Reliable and economical spool guns designed for home hobbyists and light fabricators.



Spoolmate 100

Spoolmate 100 includes carrying case that holds gun and cable, extra contact tips, nozzle and wire (wire sold separately).

Spoolmate 100 See literature M/1.45

Light industrial gun for 4043 series aluminum wire rated at 135 amps at 30 percent duty cycle.

3.7 m (12 ft.) direct-connect cable with heavy-duty strain relief provides extended reach and accessibility to your work.

Dual V-knurled drive rolls with adjustable tension control for consistent feeding of different types of wire.

Clear spool canister protects the wire and allows easy view of spool.

Includes carrying case, extra contact tips and nozzle.



Spoolmate 150

Spoolmate 150 See literature M/1.46

Light industrial gun for 4000 or 5000 series aluminum wire rated at 150 amps at 60 percent duty cycle.

6 m (20 ft.) direct-connect cable with heavy-duty strain relief provides extended reach and accessibility to your work.

Heavy-duty head tube.

Dual V-knurled drive rolls with adjustable tension control for consistent feeding of different types of wire.

Clear spool canister protects the wire and allows easy view of spool.

PORTABLE!



Spoolmate 200

Spoolmate 200 See literature M/1.47

Light industrial gun for 4000 or 5000 series aluminum wire rated at 160 amps at 60 percent duty cycle.

6 m (20 ft.) weld/control cables with strain relief and sheath provide extended reach and accessibility to your work.

Wire feed speed adjustment on the gun – not machine – for easy setup.

Easy access to drive assembly and drive rolls.

Two-stage trigger with built-in gas valve allows for gas preflow/postflow.

Toolless head tube removal allows easy replacement. Comes standard with heavy-duty head tube. Three optional head tubes available.



Spoolmate 3035

Spoolmate 3035 See literature M/1.5

Light industrial gun for 4000 or 5000 series aluminum wire rated at 150 amps at 60 percent duty cycle.

6 m (20 ft.) weld/control cables with strain relief and sheath provide extended reach and accessibility to your work.

Light weight and well balanced for operator comfort.

Clear spool canister protects the wire and allows easy view of spool.

Easy-to-remove head tube assembly.

Light industrial **CV DC**

Use with CV, DC power sources.

Processes

- MIG (GMAW) with aluminum and other soft alloy wires
- MIG (GMAW) with hard wires

Suggested power sources

For Spoolmate 100

- Millermatic® 141
- Millermatic® 211
- Multimatic™ 200/215
- Multimatic™ 220 AC/DC
- Syncrowave® 210 – requires MIG accessory kit (301254)

For Spoolmate 150

- Millermatic® 211
- Multimatic™ 200 effective with serial number MF364047N
- Multimatic™ 215/220
- Syncrowave® 210 – requires MIG accessory kit (301254)

For Spoolmate 200

- Millermatic® 212 Auto-Set™
- Millermatic® 252/255
- Multimatic™ 255

For Spoolmate 3035

- Direct connect to vintage Millermatic 210/212 tapped-voltage models
- Millermatic® 141/211 – requires SGA 100 control (043856)
- Bobcat™ 225 – requires SGA 100C control (043857)

Most popular accessories

For Spoolmate 200

- 45-Degree Head Tube 300591
- 229 mm (9 in.) Extension Head Tube 300592
- 127 mm (5 in.) Head Tube 243385
- Spoolmatic Adapter Cable 195287
Allows connection to older Millermatic 210 and 212 (non-Auto-Set).

For Spoolmatic 3035

- SGA 100 043856
- SGA 100C 043857
- Heavy-Duty Head Tube 195375

Model/ Stock Number	Welding Current Rating	Wire Feed Speed	Wire Type and Diameter Capacity	Maximum Spool Size Capacity	Dimensions	Net Weight with Cable Assembly
Spoolmate 100 (300371)	135 A at 30% duty cycle	1.7–15.9 m/min. (5–625 ipm) Wire speed dependent on power source used	Aluminum 0.8–0.9 mm (.030–.035 in.) Solid steel 0.6–0.9 mm (.023–.035 in.) Stainless 0.6–0.9 mm (.023–.035 in.)	102 mm (4 in.)	H: 291 mm (11.5 in.) W: 76 mm (3 in.) L: 330 mm (13 in.)	2.7 kg (6 lb.) 4.1 kg (9 lb.) with case
Spoolmate 150 (301272)	150 A at 60% duty cycle	2.9–18.1 m/min. (115–715 ipm) Wire speed dependent on power source used	Aluminum 0.8–0.9 mm (.030–.035 in.) Solid steel 0.8–0.9 mm (.030–.035 in.) Stainless 0.8–0.9 mm (.030–.035 in.)	102 mm (4 in.)	H: 291 mm (11.5 in.) W: 76 mm (3 in.) L: 318 mm (12.5 in.)	3.2 kg (7.3 lb.)
Spoolmate 200 (300497)	160 A at 60% duty cycle	1.8–22.2 m/min. (70–875 ipm)	Aluminum 0.8–0.9 mm (.030–.035 in.) Solid steel 0.6–0.9 mm (.023–.035 in.) Stainless 0.6–0.9 mm (.023–.035 in.)	102 mm (4 in.)	H: 229 mm (9 in.) W: 64 mm (2.5 in.) L: 368 mm (14.5 in.)	5 kg (11 lb.)
Spoolmate 3035 (195016)	150 A at 60% duty cycle, 200 A at 60% duty cycle with optional heavy-duty head tube	2.9–18.1 m/min. (115–715 ipm)	Aluminum 0.8–0.9 mm (.030–.035 in.) Solid steel 0.6–0.9 mm (.023–.035 in.) Stainless 0.6–0.9 mm (.023–.035 in.)	102 mm (4 in.)	H: 291 mm (11.5 in.) W: 57 mm (2.25 in.) L: 203 mm (8 in.)	4.1 kg (9.1 lb.)

Spoolmatic® Spool Guns

Portable, aluminum wire feeder for industrial applications.



Spoolmatic

PORTABLE!



Spoolmatic Pro

Spoolmatic See literature M/1.73

Integrated spool canister rotates 180 degrees for operator flexibility and comfort.

Available in 4.6 or 9 m (15 or 30 ft.) cable lengths, providing flexibility to be used in the shop and in the field.

Two-stage trigger with built-in gas valve allows for gas preflow, and eliminates the need to purge long gas lines.

Wire feed speed adjustment on the gun handle and reversible drive rolls save time and money.

Quick-change, single-turn contact tip provides excellent performance and is easy to replace.

Spoolmatic Pro (additional features) See literature M/1.76

Wire tension settings. 4000- or 5000-specific tension settings ensure the very best wire feeding performance and arc consistency.

More durable motor and drive design improves feedability and arc consistency while helping reduce downtime and maintenance costs.

Easy access to drive assembly and removable toolless head tube reduce service time, by allowing a means of changing drive rolls and head tube, or performing routine maintenance, without disassembly of gun.

Easy-to-rotate, self-seating head tube allows for better access into tight spots, preventing leaks and providing excellent current transfer. Head tubes are common with the XR-Aluma-Pro™ and XR™-Pistol-Pro guns.

Head tube options in several different lengths and bend configurations are available for when a standard head tube doesn't fit the application.

Industrial ● **CC CV DC**

Use with CC/CV, DC power sources.

Processes

- MIG (GMAW) with aluminum and other soft alloy wires
- MIG (GMAW) with hard wires
- Pulsed MIG (GMAW-P) with optional pulsing power source

Suggested power sources

- Millermatic® 212 Auto-Set™
- Millermatic® 252/255
- Millermatic® 350P/350P Aluminum – except Spoolmatic Pro
- Bobcat™ Series – requires WC-115A with contactor (137546011)

These power sources require WC-24 control (137549)

- AlumaPower™ MPa
- CP-302
- Deltaweld® Series
- Invision™ MPa
- Dimension™ Series
- XMT® Series
- Trailblazer® Series

Most popular accessories

- WC-115A 137546
- WC-115A with contactor 137546011
- WC-24 137549

*Spoolmatic Pro requires wire kit (230708) to run 1.6 mm (1/16 in.) wire.

Model/Stock Number	Welding Current Rating	Wire Feed Speed	Wire Type and Diameter Capacity	Maximum Spool Size Capacity	Dimensions	Gun Only Net Weight
Spoolmatic (195156) 4.5 m (15 ft.) cable (130831) 9 m (30 ft.) cable	200 A at 100% duty cycle	1.8-22.2 m/min. (70-875 ipm) Wire speed dependent on control or Millermatic used	Aluminum* 0.8-1.6 mm (.030-1/16 in.) Hard wire 0.8-1.1 mm (.030-.045 in.)	102 mm (4 in.)	H: 260 mm (10.25 in.) W: 64 mm (2.5 in.) L: 384 mm (15.125 in.)	1.3 kg (2.9 lb.)
Spoolmatic Pro (301147) 4.5 m (15 ft.) cable (301148) 9 m (30 ft.) cable	200 A at 100% duty cycle	1.8-23 m/min. (70-900 ipm) Wire speed dependent on control or Millermatic used			H: 273 mm (10.75 in.) W: 64 mm (2.5 in.) L: 390 mm (15.375 in.)	1.4 kg (3.0 lb.)



Miller recommends



Filler metals are a critical component in any weld project. They become part of your end product and choosing the right filler metal can affect the look and quality of your weld.

To make your filler metal choice easier, **Hobart offers a FREE app for download** on both Android™ and Apple® devices. Features of the app include:

- Recommendations for aluminum, carbon steel and stainless steel welding
- Calculates the amount of filler metal needed for your job
- Heat input calculator
- Hardfacing cross-reference function

Download the Filler Metal Selector and Calculator app today.

XR™ Push-Pull Guns

XR-Aluma-Pro and XR-Pistol guns work in conjunction with an XR Control, XR-AlumaFeed or select Millermatic machines to provide the best solution for push-pull applications.



XR-Aluma-Pro Lite

XR-Aluma-Pro

PORTABLE!



XR-Pistol

XR-Pistol-Pro

Threaded quick-change 360-degree rotatable head tubes are available in different bends and lengths for even those hard-to-reach welds. Over 30 different styles to fit your application and welder's preference.

Wire tension settings (except XR-Pistol). 4000- or 5000-specific tension settings ensure the very best wire feeding performance and arc consistency.

Heavy-duty construction. All internal components are designed to provide long lasting performance and feeding precision.

XR-Aluma-Pro™ Lite See literature M/1.75

Lightest weight gooseneck-style gun features rear trigger that allows access to hard-to-reach welds.

XR-Aluma-Pro™ See literature M/1.71

Robust professional-grade gun has the highest duty cycle rating in its class.

Easy access to drive assembly and removable toolless head tube reduce service time, by allowing a simple means of changing drive rolls and head tube – or performing routine maintenance without disassembly of gun.

XR™-Pistol See literature M/1.73

Reliable, cost-effective gun for light- to medium-industrial applications.



XR™-Pistol-Pro See literature M/1.74

Exceptional aluminum welding results for heavy-industrial applications.

Most durable motor and drive design improves feedability and arc consistency while helping reduce downtime and maintenance costs.

Easy access to drive assembly and removable toolless head tube reduce service time, by allowing a simple means of changing drive rolls and head tube – or performing routine maintenance without disassembly of gun.

Industrial ● XR-Aluma-Pro Lite
Heavy Industrial ● XR-Aluma-Pro and all Pistol models

  Use with CC/CV, DC power sources.

Processes

- MIG (GMAW) with aluminum wire (capable of other wires with optional hardwire kits)
- Pulsed MIG (GMAW-P) with optional pulsing power source

Suggested feeders/controls

- XR-AlumaFeed® SuitCase® 301567 301593, CE



Suggested power sources

- Millermatic® 252
 - Millermatic® 255 (XR-Aluma-Pro guns only)
 - Millermatic® 350P/350P Aluminum
- These power sources require an XR-AlumaFeed SuitCase*
- Deltaweld® 350/500 (14-pin receptacle models only)
 - Invision™ MPa
 - XMT® Series
 - Trailblazer® Series

Most popular accessories

- Hardwire Liner Kit 198377

*Dependent on control box or Millermatic used. **Requires wire kit (230708) to run 1.6 mm (1/16 in.) wire.

Model	Cable Length				Welding Current Rating	Wire Feed Speed*	Wire Type and Diameter Capacity	Dimensions	Gun Only Net Weight
	4.6 m (15 ft.)	7.6 m (25 ft.)	9 m (30 ft.)	10.6 m (35 ft.)					
XR-Aluma-Pro Lite (Air-cooled)	–	(300948)	–	–	175 A at 60% duty cycle	1.8–23 m/min. (70–900 ipm)	Aluminum 0.8–1.2 mm (.030–.047 in.)	H: 102 mm (4 in.) W: 48 mm (1.9 in.) L: 381 mm (15 in.)	0.9 kg (2.0 lb.)
XR-Aluma-Pro (Air-cooled)	(301568)	(301569)	–	(301570)	300 A at 100% duty cycle	1.8–23 m/min. (70–900 ipm)	Aluminum** 0.8–1.6 mm (.030–1/16 in.)	H: 127 mm (5 in.) W: 64 mm (2.5 in.) L: 432 mm (17 in.)	1.1 kg (2.5 lb.)
XR-Aluma-Pro (Water-cooled)	(301571), CE	(301572), CE	–	(301573), CE	400 A at 100% duty cycle				1.3 kg (2.9 lb.)
XR-Pistol (Air-cooled)	(198127), CE	–	(198128), CE	–	200 A at 100% duty cycle	1.8–22.2 m/min. (70–875 ipm)	Aluminum 0.8–1.6 mm (.030–1/16 in.)	H: 187 mm (7.375 in.) W: 48 mm (1.875 in.) L: 270 mm (10.625 in.)	1 kg (2.2 lb.)
XR-Pistol (Water-cooled)	(198129), CE	–	(198130), CE	–	400 A at 100% duty cycle				1.1 kg (2.4 lb.)
XR-Pistol-Pro (Air-cooled)	(300782)	(300783)	–	(300784)	200 A at 100% duty cycle	1.8–23 m/min. (70–900 ipm)	Aluminum** 0.8–1.6 mm (.030–1/16 in.)		1 kg (2.2 lb.)
XR-Pistol-Pro (Water-cooled)	(300786)	(300787)	–	(300788)	400 A at 100% duty cycle				1.1 kg (2.4 lb.)

Multimatic® 200 and 215

See literature DC/12.57 (200) and DC/12.59 (215)



Multi-voltage plug (MVP™) allows connection to common 120- and 240-volt power receptacles without the use of any tools – simply choose the plug that fits the receptacle and connect to the power cord.



Light industrial ●  **DC 1** Phase

Processes

- MIG (GMAW) ▪ Flux-cored (FCAW)
- DC stick (SMAW) ▪ DC TIG (DC GTAW)

Comes complete with

- 3 m (10 ft.) 250-amp MDX™-250 MIG gun (Multimatic 200) **OR** 3 m (10 ft.) 100-amp MDX™-100 MIG gun (Multimatic 215)
- 4 m (13 ft.) cable with electrode holder and 25 mm Dinse-style connector
- 3 m (10 ft.) work cable with clamp and 25 mm Dinse-style connector
- Power cord with MVP plugs for 120 V and 240 V
- Quick Select™ drive roll for 0.6 mm (.024 in.) or 0.8/0.9 mm (.030/.035 in.) solid wire, and 0.8/0.9 mm (.030/.035 in.) flux-cored wire

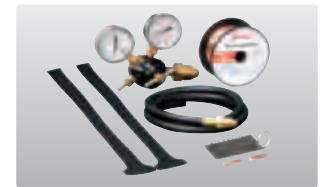

- Flow gauge regulator and gas hose for argon or AR/CO₂ mix, extra MDX contact tips, information/settings chart and material thickness gauge (229895) – Hobart® spool of 0.8 mm (.030 in.) solid wire and hook-and-loop cord wraps as seen in photo above are included with Multimatic 215 model only

Most popular accessories

- Spoolmate™ Spool Guns
300371 Spoolmate 100
301272 Spoolmate 150
- Running Gear/Cylinder Rack 301239
- Protective Cover 301262 (for Multimatic 215 only)
- TIG Contractor Kits
301287 For Multimatic 200
301337 For Multimatic 215

Welding Capability

Max. 9.5 mm (3/8 in.)	Max. 9.5 mm (3/8 in.)
MIG Mild Steel	MIG Aluminum
Min. 0.6 mm (24 ga.)	Min. 1.2 mm (18 ga.)
Max. 4.8 mm (3/16 in.)	Stick Mild Steel
TIG Mild Steel	
Min. 0.6 mm (24 ga.)	Min. 1.5 mm (16 ga.)

Aluminum welding uses optional Spoolmate 100 and 4000 series aluminum wire **OR** Spoolmate 150 (effective with Multimatic 200 serial number MF364047N) and either 4000 or 5000 series aluminum wire. TIG welding uses optional TIG contractor kit.

Weighing only **13 kg (29 lb.) (200)** or **17 kg (38 lb.) (215)**, these lightweight MIG, stick and TIG welders provide portability on the job.

Impact-resistant, flame-retardant case (200 only) provides strength and durability, while protecting components and welding wire from moisture, dust and other contaminants.

Auto-Set™ Elite can be used on multiple materials and multiple processes with the ability to fine-tune your settings. Easy to set up and use!

Excellent arc characteristics! Positive arc starts and an extremely stable arc with minimal spatter.

Auto Spool Gun Detect™ automatically detects when a MIG gun or spool gun is connected, eliminating the need for a switch.

Multimatic 215 model additional features

Intuitive color LCD interface makes it quick and easy to adjust parameters.



Angled cast-aluminum drive system provides smooth feeding and the ability to use 3, 3.7 or 4.6 m (10, 12 or 15 ft.) guns.

Model/Stock Number	Welding Mode/Process	Input Power	Amperage Range	Rated Output	Amps Input at Rated Output, 50/60 Hz				Wire Feed Speed	Max. Open-Circuit Voltage	Dimensions	Net Weight		
					120 V	230 V/240 V	KVA	KW						
Multimatic 200 (907518)	CV: MIG/flux-cored	120 V	30-140	90 A at 18.5 V, 60% duty cycle	18.0	–	2.2	2.0	1.8-10.8 m/min. (70-425 ipm)	90 VDC (22-25 VDC, sense voltage for stick and Lift-Arc™ TIG)	H: 368 mm (14.5 in.) W: 248 mm (9.75 in.) D: 432 mm (17 in.)	13.2 kg (29 lb.)		
				110 A at 19.5 V, 20% duty cycle	22.4	–	2.7	2.6						
	230 V	30-200	150 A at 21.5 V, 20% duty cycle	–	17.5	4.0	3.8							
			150 A at 16 V, 30% duty cycle	27.0	–	3.3	3.2							
	CC: TIG	120 V	5-150	150 A at 16 V, 30% duty cycle	–	13.8	3.2	3.0						
				230 V	5-150	150 A at 16 V, 30% duty cycle	–	20.8	4.8				4.5	
Multimatic 215 (907693)	CV: MIG/flux-cored	120 V	30-125	110 A at 19.5 V, 60% duty cycle	23.0	–	2.8	2.8	1.5-15.2 m/min. (60-600 ipm)	58 VDC	H: 318 mm (12.5 in.) W: 286 mm (11.25 in.) D: 521 mm (20.5 in.)	17.2 kg (38 lb.)		
				240 V	30-230	200 A at 24 V, 20% duty cycle	–	25.8					6.2	6.2
						150 A at 21.5 V, 40% duty cycle	–	16.7					4.0	4.0
	CC: TIG	120 V	20-150	140 A at 15.6 V, 40% duty cycle	24.6	–	3.0	3.0						
				240 V	20-210	190 A at 17.6 V, 20% duty cycle	–	18.0	6.7				6.7	
						120 V	30-100	90 A at 23.6 V, 40% duty cycle	22.7				–	2.7
240 V	30-200	190 A at 27.6 V, 20% duty cycle	–	27.0	6.5			6.5						

Multimatic® 220 AC/DC See literature DC/12.65



Multi-voltage plug (MVP™) allows connection to common 120- and 240-volt power receptacles without the use of any tools – simply choose the plug that fits the receptacle and connect to the power cord.



With MDX Series MIG gun.

Welding Capability

Max. 9.5 mm (3/8 in.)	Max. 9.5 mm (3/8 in.)
MIG Mild Steel	MIG Aluminum
Min. 0.6 mm (24 ga.)	Min. 1.2 mm (18 ga.)
Max. 6.4 mm (1/4 in.)	Max. 6.4 mm (1/4 in.)
TIG Mild Steel	TIG Aluminum
Min. 0.6 mm (24 ga.)	Min. 0.6 mm (24 ga.)
Max. 9.5 mm (3/8 in.)	
Stick Mild Steel	
Min. 1.5 mm (16 ga.)	

MIG aluminum welding uses optional Spoolmate 100 and 4000 series aluminum wire OR Spoolmate 150 and either 4000 or 5000 series aluminum wire.

All in one. Comes equipped with all accessories to MIG, stick, AC and DC TIG weld with one machine – unlike other machines where you need to purchase additional accessories.

Innovative QuickTech™ technology makes setup and changing processes even easier.

- Automatically determines the polarity. Work is always connected to the bottom right receptacle. MIG gun and TIG torch can stay connected at the same time.
- Automatically switches to the right process. Just hit the trigger or the foot control and the machine automatically changes, eliminating the need to manually change processes.
- Automatically recalls the settings from the last process used.

Auto-Set™ Elite can be used on multiple materials and multiple processes with the ability to fine-tune your settings. Easy to set up and use!

Pro-Set™ (TIG/stick) eliminates the guesswork when setting weld parameters. Use Pro-Set when you want the speed, convenience and confidence of preset controls.

Intuitive color LCD interface makes it quick and easy to adjust parameters.



Weighing only 56 pounds, this lightweight MIG, stick and AC/DC TIG welder provides portability on the job.

Two shielding gas connections (one for MIG gas and one for TIG gas) so both gases can be left connected to the machine – no switching needed.

Manual mode offers additional TIG adjustments for increased control including AC balance, AC frequency and DC pulsing.

TIG high-frequency (HF) arc starting for non-contact arc initiation, reducing tungsten and material contamination.

Light Industrial    

- Processes**
- MIG (GMAW) ▪ Flux-cored (FCAW)
 - DC stick (SMAW) ▪ AC/DC TIG (GTAW)
 - Pulsed TIG (GTAW-P)

- Comes complete with**
- 3 m (10 ft.) 100-amp MDX™-100 MIG gun
 - 4 m (13 ft.) cable with electrode holder and 25 mm Dinse-style connector
 - 3.8 m (12.5 ft.) Weldcraft™ A-150 (WP-17) TIG torch with 25 mm Dinse-style connector
 - 3 m (10 ft.) work cable with clamp and 25 mm Dinse-style connector
 - 2 m (6.5 ft.) power cord with MVP plugs for 120 V and 240 V
 - RFCS-14 HD foot control with 6 m (20 ft.) cord
 - Quick Select™ drive roll for 0.6 mm (.024 in.) or 0.8/0.9 mm (.030/.035 in.) solid wire, and 0.8/0.9 mm (.030/.035 in.) flux-cored wire
 - Two flow gauge regulators and gas hoses for argon or AR/CO₂ mix, extra contact tips, Hobart® spool of .030 in. solid wire, AK2C TIG torch accessory kit, hook-and-loop cord wraps and material thickness gauge (229895)

- Most popular accessories**
- Spoolmate™ Spool Guns
 - 300371 Spoolmate 100
 - 301272 Spoolmate 150
 - Dual Cylinder Rack Cart
 - Protective Cover 301524
 - Wireless Remote Foot Control 300429
 - Running Gear Cylinder Rack 301239
 - Dual Cylinder Rack Conversion Kit 301454

Stock Number (907757)	Welding Mode/Process	Input Power	Amperage Range	Rated Output	Amps Input at Rated Output, 50/60 Hz				Wire Feed Speed	Max. Open-Circuit Voltage	Dimensions	Net Weight
					120 V	240 V	KVA	KW				
CV: MIG/flux-cored	120 V	30-125 A	105 A at 19.2 V, 60% duty cycle	23.3	–	2.8	2.8	1.5-15.2 m/min. (60-600 ipm)	45 VDC	H: 445 mm (17.5 in.) W: 286 mm (11.25 in.) D: 546 mm (21.5 in.)	25.3 kg (56 lb.)	
				–	27.2	4.8	4.8					
	240 V	30-230 A	200 A at 24 V, 20% duty cycle	–	21.5	3.8	3.8					
CC: TIG	120 V	20-140 A	130 A at 15.2 V, 40% duty cycle	24.0	–	2.9	2.9	–	46 VDC			
	240 V	20-210 A	210 A at 18.4 V, 20% duty cycle	–	22.4	5.4	5.4					
CC: Stick	120 V	30-90 A	90 A at 23.6 V, 40% duty cycle	24.5	–	2.9	2.9					
	240 V	30-200 A	200 A at 28.4 V, 15% duty cycle	–	31.3	7.5	7.5					

Multimatic® 235

See literature DC/14.0



Multimatic 235 with running gear package shown.



Welding Capability

Max. 9.5 mm (3/8 in.)	Max. 9.5 mm (3/8 in.)
Mild Steel	Aluminum
Min. 0.6 mm (24 ga.)	Min. 1.2 mm (18 ga.)
Max. 6.4 mm (1/4 in.)	Max. 9.5 mm (3/8 in.)
TIG Mild Steel	Stick Mild Steel
Min. 0.6 mm (24 ga.)	Min. 1.5 mm (16 ga.)

Aluminum welding uses optional spool guns.
TIG welding uses optional Multimatic 235/255 TIG kit.



Easy-to-understand interface with 109 mm (4.3 in.) color LCD display and intuitive connection setup images.

Weighing only 28.6 kg (63 lb.) (machine only), this lightweight MIG, stick and DC TIG welder provides portability on the job.

Compatible with Spoolmate™ 100, 150 and 200, and Spoolmatic 15A and 30A spool guns to offer a variety of aluminum welding solutions.

EXCLUSIVE! Auto-Gun Detect™ automatically adjusts voltage, wire speed and timers for faster switching between MIG and spool guns.

Heavy-duty aluminum two-drive-roll system.

Uses 102, 203 or 305 mm (4, 8 or 12 in.) spools.

Auto-Set™ Elite offers predefined weld settings to increase ease of use and ensure that the job is done right for operators of all skill levels.

- Available for MIG, stick and DC TIG processes with the ability to fine-tune your settings
- Set weld parameters by:
 - MIG – selecting wire and gas type, wire diameter and material thickness
 - Stick – selecting electrode type, electrode diameter and material thickness
 - DC Lift-Arc™ TIG – selecting remote on/off, tungsten diameter and material thickness

Pro-Set™ (TIG/stick) eliminates the guesswork when setting weld parameters. Use Pro-Set when you want the speed, convenience and confidence of preset controls.

Two shielding gas connections (one for MIG gas and one for TIG gas) so both gases can be left connected to the machine – no switching needed.

Manual mode offers additional stick and TIG adjustments for increased control including adjustable DIG control for stick and 0.1–150 pulses per second for DC pulsed TIG.

Fan-On-Demand™ cooling system only operates when needed, reducing power consumption and keeping internal components cleaner.

Industrial ● CC CV DC 1 Phase

Processes

- MIG (GMAW) ▪ Flux-cored (FCAW)
- DC stick (SMAW)
- DC Lift-Arc™ TIG (GTAW)
- Pulsed TIG (GTAW-P)

Comes complete with

- 4.5 m (15 ft.) 250-amp MDX™-250 MIG gun with AccuLock™ MDX™ consumables
- 3 m (10 ft.) cable with electrode holder
- 3 m (10 ft.) work cable with clamp
- 2.1 m (7 ft.) industrial power cord
- Two factory-installed gas solenoids
- Flow gauge regulator and gas hose for argon or AR/CO₂ mix
- Chain to secure gas cylinder
- 0.8/0.9 mm (.030/.035 in.) reversible V-groove drive rolls
- Extra contact tips and material thickness gauge (229895)

Most popular accessories

- Spoolmate™ Spool Guns
 - 300371 Spoolmate 100
 - 301272 Spoolmate 150
 - 300497 Spoolmate 200
- Spoolmatic® Spool Gun (non-Pro gun only)
- EZ-Latch™ Single Cylinder Running Gear 301449
- EZ-Latch™ Dual Cylinder Rack with Elevated Gun and Cable Rack 301481
 - Converts an EZ-Latch™ Single Cylinder Running Gear into a Dual Cylinder Rack Running Gear
- Protective Cover 301521
- Multimatic 235/255 TIG Kit 301518
- 10-Pin to 14-Pin Adapter Cord 301545
- Wireless Remote Foot Control 300429

*Input voltage range for the Multimatic 235 is 204–276 V.

Stock Number (907780) 240 V	Welding Mode/Process	Amperage Range	Rated Output	Amps Input at Rated Output, 50/60 Hz 240 V*			Wire Feed Speed	Max. Open-Circuit Voltage	Power Source Dimensions	Power Source Net Weight
				KVA	KW					
	CV: MIG/flux-cored	30–235	170 A at 22.5 V, 60% duty cycle	20.0	5.0	4.9	1.5–15.2 m/min. (60–600 ipm)	54 VDC	H: 489 mm (19.24 in.) W: 349 mm (13.75 in.) D: 616 mm (24.25 in.)	29 kg (63 lb.)
	CC: Stick	30–200	150 A at 26 V, 60% duty cycle	20.2	5.0	4.8	–			
	CC: DC TIG	20–210	180 A at 17.2 V, 60% duty cycle	17.0	4.2	4.1	–			

Multimatic® 255

See literature DC/12.9



Multimatic 255 with running gear

Welding Capability	
Max. 13 mm (1/2 in.)	Max. 13 mm (1/2 in.)
Mild Steel	Aluminum
Min. 0.8 mm (22 ga.)	Min. 1.2 mm (18 ga.)
Max. 9.5 mm (3/8 in.)	Max. 7.9 mm (5/16 in.)
TIG Mild Steel	Stick Mild Steel
Min. 0.6 mm (24 ga.)	Min. 1.5 mm (16 ga.)



Aluminum welding uses optional XR-Aluma-Pro push-pull gun. TIG welding uses optional Multimatic 255 TIG kit.



Easy-to-understand interface with 7-inch color LCD display ensures proper machine setup and parameter selection, reducing setup time and increasing weld time.

- Quick-access process and weld mode backlit buttons across the top illuminate when active
- Soft-key buttons below the display change function depending on which screen is displayed – makes setup or change quick, easy and intuitive
- Large text for easier readability
- Intuitive connection setup images
- Full troubleshooting descriptions versus help errors and look up codes

AUTO-LINE TECHNOLOGY Allows for any input voltage hookup (208–575 V, single-phase) with no manual linking, providing convenience in any job setting. Ideal solution for dirty or unreliable power.

Auto-Set™ Elite offers predefined weld settings to increase ease of use and ensure that the job is done right for operators of all skill levels.

- Available for MIG, pulsed MIG, stick and DC TIG processes with the ability to fine-tune your settings
- Set weld parameters by:
 - MIG – selecting wire and gas type, wire diameter and material thickness
 - Stick – selecting electrode type, electrode diameter and material thickness
 - DC Lift-Arc™ TIG – selecting remote on/off, tungsten diameter and material thickness

Built-in pulsed MIG programs. All programmed information is restored after each power up – aluminum/steel/stainless steel.

Program mode allows easy save and recall of favorite weld settings. Save up to four programs for each process. Delivers more productivity and consistent quality while minimizing supervisor intervention.

EXCLUSIVE! Auto-Gun Detect™ automatically adjusts voltage, wire speed and timers for faster switching between MIG, push-pull and spool guns.

Heavy-duty aluminum two-drive-roll system.

Fan-On-Demand™ cooling system only operates when needed, reducing power consumption and keeping internal components cleaner.

Industrial  

- Processes**
- MIG (GMAW) ▪ Flux-cored (FCAW)
 - Pulsed MIG (GMAW-P)
 - DC stick (SMAW)
 - DC Lift-Arc™ TIG (GTAW)
 - Pulsed TIG (GTAW-P)

- Multimatic 255 comes complete with**
- 4.5 m (15 ft.) 250-amp MDX™-250 MIG gun with Bernard® AccuLock™ S consumables
 - 3 m (10 ft.) cable with electrode holder
 - 3 m (10 ft.) work cable with clamp
 - 3 m (10 ft.) industrial power cord
 - Factory-installed gas solenoid
 - Flow gauge regulator and gas hose for argon or AR/CO₂ mix
 - Chain to secure gas cylinder
 - .035/.045 in. reversible V-groove drive rolls
 - Extra contact tips and material thickness gauge (229895)

- Most popular accessories**
- MDX™-250 EZ-Select™ MIG Gun 1770047
 - Spoolmatic® Spool Guns
 - XR-Aluma-Pro™ Air-Cooled Push-Pull Guns
 - EZ-Latch™ Single Cylinder Running Gear 301449
 - EZ-Latch™ Dual Cylinder Rack with Elevated Gun and Cable Rack 301481
 - Protective Cover 301521
 - Multimatic 255 TIG Kit 301518
 - 10-Pin to 14-Pin Adapter Cord 273873

Stock Number (907728) 208–575 V	Welding Mode/Process	Amperage Range	Rated Output	Amps Input at Rated Output, 50/60 Hz						Wire Feed Speed	Max. Open-Circuit Voltage	Power Source Dimensions	Power Source Net Weight
				208 V	240 V	460 V	575 V	KVA	KW				
	CV: MIG/flux-cored	20–350	230 A at 25.5 V, 60% duty cycle	34.7	29.7	17.1	14.3	8.2	8.2	1.3–20 m/min. (50–800 ipm)	81 VDC	H: 489 mm (19.24 in.) W: 349 mm (13.75 in.) D: 667 mm (26.25 in.)	38 kg (84 lb.)
	CC: Stick	30–275	200 A at 28 V, 60% duty cycle	33.5	29	16.4	13.6	7.8	7.8	–			
	CC: DC TIG	5–275	275 A at 21 V, 60% duty cycle	34.1	29.9	17	14.1	8.1	8.1	–			

Maxstar 280 Multiprocess Dynasty® 280 DX Multiprocess

See literature DC/35.5 (Maxstar) and AD/4.95 (Dynasty)

Multiprocess performance in a portable package. Designed for industrial applications that require a versatile solution with superior arc performance.



Maxstar 280 Multiprocess (far left) and Dynasty 280 DX Multiprocess shown with ArcReach SuitCase 8 (sold separately).

ArcReach SuitCase feeder paired with the CV output of the Maxstar or Dynasty power source gives this unit MIG process capabilities.

Note: Maxstar and Dynasty are not capable of ArcReach control.

AUTO-LINE TECHNOLOGY Allows for any input voltage hook-up (208–575 V) with no manual linking, providing convenience in any job setting. Ideal solution for dirty or unreliable power.

Blue Lightning™ high-frequency (HF) arc starter for non-contact arc initiation. Provides more consistent arc starts and greater reliability compared to traditional HF arc starters.

Pulsed TIG can be used to increase puddle agitation, arc stability and travel speeds while reducing heat input and distortion.

Fan-On-Demand™ cooling system only operates when needed, reducing power consumption and keeping internal components cleaner.

Cooler-On-Demand™ feature operates the auxiliary cooling system only when needed. Reduces noise, energy use, and airborne contaminants pulled through the cooler.



Dynasty 280 DX Multiprocess with accessories shown.

Industrial ●   

Processes

- AC/DC TIG (GTAW) ▪ Pulsed TIG (GTAW-P)
- MIG (GMAW)² ▪ Flux-cored (FCAW)²
- Stick (SMAW) ▪ Air carbon arc (CAC-A)

¹Dynasty model only.

²With ArcReach SuitCase wire feeder.

Comes with

- 2.4 m (8 ft.) power cord (no plug)
- Two 50 mm Dinse-style connectors
- Two Dinse/Tweco® adapters
- 2.4 m (8 ft.) weld cable with Tweco®-style connectors to power feeder
- Quick reference guide

Most popular accessories

- ArcReach® SuitCase® Feeders
- Small Runner™ Cart 301318
- Coolmate™ 1.3 300972
- Contractor Kits
 - 301311 w/RCCS-14 finger control
 - 301309 w/RFCs-14 HD foot control
- Weldcraft™ Water-Cooled Torch Kits
 - 300185 W-250 (WP-20)
 - 300990 W-280 (WP-280)
 - 301268 W-375
- Remote Controls

*Refer to owner's manual for complete ratings.
**Sense voltage for low OCV stick and Lift-Arc™ TIG.

	Model/Stock Number	Welding Process	Input Power	Welding Amp Range	Rated Output at 60% Duty Cycle	Amps Input at Rated Load Output, 50/60 Hz					Max. Open-Circuit Voltage	Power Source Dimensions	Power Source Net Weight		
					208 V	230 V	400 V	460 V	575 V	KVA	KW				
DC Maxstar	Maxstar 280 Multiprocess (907552001) Power source only	TIG	3-phase	1-280	250 A at 20 V	21	19	11	9	7	7.6	7.3	60 VDC (11 VDC**)	H: 346 mm (13.6 in.) W: 219 mm (8.6 in.) D: 569 mm (22.5 in.)	21.3 kg (47 lb.)
			1-phase	1-280	250 A at 20 V	35	32	18	16	13	7.3	7.1			
		Stick	3-phase	5-280	250 A at 30 V	*	*	14	13	10	9.9	9.6			
			1-phase	5-280	180 A at 27.2 V	32	29	*	*	*	6.7	6.5			
		MIG/flux-cored	3-phase	5-280	250 A at 26.5 V	*	*	13	11	9	9.2	8.9			
1-phase	5-280	200 A at 24 V	31	29	*	*	*	6.5	6.3						
AC/DC Dynasty	Dynasty 280 DX Multiprocess (907514007) Power source only (907514008) Power source only, CE	TIG	3-phase	2-280 (AC) 1-280 (DC)	250 A at 20 V	21	19	11	9	7	7.6	7.3	60 VDC (11 VDC**)	H: 346 mm (13.6 in.) W: 219 mm (8.6 in.) D: 569 mm (22.5 in.)	25 kg (55 lb.)
			1-phase	2-280 (AC) 1-280 (DC)	250 A at 20 V	35	32	18	16	13	7.3	7.1			
		Stick	3-phase	5-280	250 A at 30 V	*	*	14	13	10	9.9	9.6			
			1-phase	5-280	180 A at 27.2 V	32	29	*	*	*	6.7	6.5			
		MIG/flux-cored	3-phase	5-280	250 A at 26.5 V	*	*	13	11	9	9.2	8.9			
1-phase	5-280	200 A at 24 V	31	29	*	*	*	6.5	6.3						

XMT® Series

Portability and excellent multiprocess arc performance make the XMT family the most popular in the industry. With many models to choose from the XMT family has the right solution for your business.



Input power choices

AUTO-LINE™ TECHNOLOGY (350/425 models) allows for any input voltage hookup (230–575 V, three-phase) with no manual linking, providing convenience in any job setting. Ideal solution for dirty or unreliable input power.

Standard hookup (450 models). Available as 400 V, three-phase.

Advanced features for the professional welder

Adaptive Hot Start™ makes starting stick electrodes easy without creating an inclusion.

Infinite arc control available in the stick and wire modes for easier fine tuning of tough-to-weld materials and out-of-position applications.

Lift-Arc™ provides arc starting that minimizes contamination of the electrode and without the use of high frequency.

Insight Core™ Welding Intelligence™ system. XMT 14-pin models are Insight Core capable to monitor weld voltage, amperage, and arc-time and percentage.

Reliability

Wind Tunnel Technology™ Air flow that protects internal components, greatly improving reliability.

Fan-On-Demand™ cooling system operates only when needed, reducing noise, energy use and amount of contaminants pulled through machine.

Welder friendly control panel

Process selector switch reduces the number of control setup combinations without reducing any features.

Ultra-tough, polycarbonate-blended cover protects front controls from damage.

Large, dual digital meters are easy to view and presettable to ease setting weld output.

Output connector choices

Dinse-style weld disconnects (350/425 models) provide high-quality weld cable connections. Machines come with two Dinse connectors.

Weld studs (450 models).

14-pin receptacle provides a quick, direct connection to Miller® wire feeders. Capable of remote voltage control.

Choose the Right XMT

	350 Amp			450 Amp	
	XMT 350 CC/CV	XMT 350 MPa	XMT 425 CC/CV	XMT 450 CC/CV	XMT 450 MPa
Input Power	3-phase			3-phase	
Primary Operating Range	Auto-Line (230–575 V)			400 V	
Weld Output	350 A at 34 VDC (3-phase input power at 60% duty cycle)		425 A at 27 VDC (3-phase input power at 30% duty cycle)	UPGRADE	450 A at 38 VDC (3-phase input power at 100% duty cycle)
Carbon Arc Gouging	Rated: 6 mm		Rated: 6 mm	UPGRADE	Rated: 7.9 mm
Net Weight	36.3 kg (80 lb.)		36.3 kg (80 lb.)	55.3 kg (122 lb.)	
Output Connector	Dinse		Dinse	1/2 in. stud	
Pulsed MIG	–	UPGRADE Yes	–	UPGRADE Yes	–
14-pin Compliant	Yes		Yes	Yes	
Insight Core Capable (requires Insight Core 14-pin module)	Yes		Yes	Yes	

XMT® 350 CC/CV, 425 CC/CV and 450 CC/CV

See literature DC/18.93 (350), EX/18 (425) and DC/18.94 (450)

Flexibility and simplicity make this the most popular model. It has the core multiprocess capabilities along with the flexibility of a 14-pin for spool guns, feeders, and remote controls.

Stronger weld output for increased capabilities. XMT 350 provides 24 percent more output than the 304 model for larger wires and stick electrodes. XMT 450 provides 43 percent more output for carbon arc gouging.



XMT® 350 MPa and 450 MPa

See literature DC/18.93 (350) and DC/18.94 (450)

Built-in pulse programs for manufacturing and fabrication applications that have benefits for standard steels, high-strength steels and aluminum.

Pulse programs provide reduced heat affected zone, weld in all positions, great for thick-to-thin metal, good gap filling ability and faster travel speeds and deposition.

SharpArc® controls the arc in pulsed MIG mode and gives total control over the arc cone shape, puddle fluidity and bead profile.

Additional features when using a 70 Series MPa Plus feeder or XR-AlumaFeed® SuitCase® feeder.

Synergic pulsed MIG.

As you increase/decrease the wire feed speed, the pulse parameters increase/decrease, matching the right amount of power output to match the wire speed, eliminating the need to make additional adjustments.



Profile Pulse™ provides TIG appearance with MIG simplicity and productivity. Achieve “stacked dimes” without gun manipulation. Profile Pulse frequency can be changed to increase or decrease the spacing between the ripple pattern to achieve the desired weld appearance.



Added capabilities with Insight Core™ When using an MPa Plus feeder, wire deposition is added to the Insight Core capabilities.

Heavy industrial 

Processes

- MIG (GMAW) ▪ Pulsed MIG (GMAW-P)*
- Stick (SMAW) ▪ TIG (GTAW)
- Flux-cored (FCAW)
- Air carbon arc cutting and gouging (CAC-A) (carbons – 350/425: 6 mm, 450: 8 mm)

*Only XMT MPa models.

Most popular accessories

- XR-AlumaFeed®
- SuitCase® Feeders
- 70 Series Feeders
- XR™ Control
- Universal Running Gear
- MIGRunner™ Cart 195445
- Running Gear Cylinder Rack 300408
- Coolmate™ Coolant System
- Industrial MIG 4/0 Kits 300405 (Dinse) 300390 (Lugs)
- Gas Valve Kit 195286 XMT 350/425 300928 XMT 450

*Optional 115-volt auxiliary power provides 10 amps of circuit-breaker protected power for coolant systems, etc.

**Duty cycle rating below achieved with 6-gauge input power cord (8-gauge cord supplied with unit).

Model/Stock Number	Input Power	Amperage/ Voltage Ranges	Rated Output	Amps Input at Rated Load Output							Max. Open-Circuit Voltage	Dimensions	Net Weight
				208 V	230 V	400 V	460 V	575 V	KVA	KW			
XMT 350 CC/CV (Dinse) (907161) 208-575 V, 50/60 Hz (907161011) 208-575 V, w/auxiliary power*, 50/60 Hz (907161012) Auto-Line w/auxiliary power, 50/60 Hz, CE	3-phase	5-425 A 10-38 V	350 A at 34 VDC, 60% duty cycle	40.4	36.1	20.6	17.8	14.1	14.2	13.6	75 VDC	H: 432 mm (17 in.) W: 318 mm (12.5 in.) D: 610 mm (24 in.)	36.3 kg (80 lb.) 43 kg (94.8 lb.) w/aux power
	1-phase	5-425 A 10-38 V	300 A at 32 VDC, 60% duty cycle	60.8	54.6	29.7	24.5	19.9	11.7	11.2			
XMT 350 MPa (Dinse except where noted) (907366) 208-575 V, 50/60 Hz (907366011) 208-575 V, w/auxiliary power*, 50/60 Hz (907366014) 208-575 V, with Tweco®, 50/60 Hz (907366002) w/auxiliary power, 50/60 Hz, CE	3-phase		425 A at 27 VDC, 30% duty cycle	–	36.1	20.6	17.8	14.1	14.2	13.6	90 VDC	H: 438 mm (17.25 in.) W: 368 mm (14.5 in.) D: 689 mm (27.125 in.)	55.3 kg (122 lb.)
XMT 425 CC/CV (907386) 230-575 V, 50/60 Hz	3-phase	15-600 A 10-38 V	450 A at 38 VDC, 100% duty cycle	–	51	–	27.6	24.4	22	18.9			
XMT 450 CC/CV (907481) 230/460 V, 60 Hz (907525) 400 V w/auxiliary power*, 50/60 Hz, CE	3-phase			–	51	–	27.6	23.6	21.6	18.3	90 VDC	H: 438 mm (17.25 in.) W: 368 mm (14.5 in.) D: 689 mm (27.125 in.)	55.3 kg (122 lb.)
XMT 450 MPa (907479) 230/460 V, 60 Hz (907468) 400 V, w/auxiliary power, 50/60 Hz, CE				–	51	–	27.6	23.6	21.6	18.3 (KVA is 23.5 on 575 V)			

XMT® 350 FieldPro™ Systems See literature DC/18.96

ArcReach®

Every year, outdated welding equipment wastes hundreds of productive work hours – and thousands of dollars in profit – by forcing operators to make numerous walks from the weld joint to the welder. Welding systems with ArcReach technology let operators adjust welding parameters right at the weld joint without a control cord using the wire feeder or remote – maximizing arc-on time, improving safety and impacting the bottom line.

Don't walk. Weld! Learn more at MillerWelds.com/arcreach



Top row left to right: ArcReach SuitCase 12 feeder, XMT 350 FieldPro power source, XMT 350 FieldPro with Polarity Reversing power source, and ArcReach Smart Feeder. Bottom row left to right: ArcReach Stick/TIG Remote and ArcReach Stick/TIG Remote with Polarity Reversing.

More jobsite productivity and efficiency

Cable Length Compensation (CLC™) ensures that the voltage a weld operator sets is the voltage they get by automatically adjusting voltage based on weld cable length, even hundreds of feet away from the power source.

AUTO-LINE TECHNOLOGY For portability and reliability, Auto-Line allows for any input voltage hookup (208–575 V, single- or three-phase) with no manual linking, providing convenience in any job setting. Ideal solution for dirty or unreliable power.

Auto-Bind™ automatically establishes exclusive communication between the power source and the wire feeder, using the existing weld cables upon system power up.

Exceptional arc performance

Common weld failures can be minimized with stick stops that are specifically programmed to eliminate arc strikes outside of the heat-affected zone.

Regulated Metal Deposition (RMD®) and pulsed MIG are fully supported, enabling operators to use these advanced processes in the field for faster, more-efficient welds.

Increased uptime

Delivers the performance you need. XMT 350 FieldPro welders and ArcReach feeders and remotes have been extensively field-proven.

Wind Tunnel Technology™ Internal air flow that protects electrical components and PC boards from dirt, dust, debris... greatly improving reliability.

Eliminate expenses related to maintaining or replacing easily damaged control cords because the weld cables are used to communicate weld parameters between the wire feeder and power source.

Improved jobsite safety

Decrease the chances of slip, trip or fall injuries because ArcReach technology allows weld operators to make parameter changes at the wire feeder or remote instead of having to travel through multistory and cluttered jobsites back to the power source.

Maximum fleet compatibility

Maximize fleet compatibility and get the benefits of ArcReach when you pair XMT 350 FieldPro welders and ArcReach feeders with other ArcReach compatible products.

More operator control

Weld operators can Adjust While Welding (AWW™) to change weld parameters while the arc is on.

Inadvertent parameter changes by other jobsite workers can be easily avoided because connecting an ArcReach accessory from the power source automatically locks out the power source's panel controls.

Return to a previous weld process faster because the power source is restored to its previous settings once the ArcReach accessory is removed.

Decrease the chance of an incorrect weld process being used because Auto-Process Select™ automatically sets the power source to the correct weld process based on the polarity applied to the weld accessory.

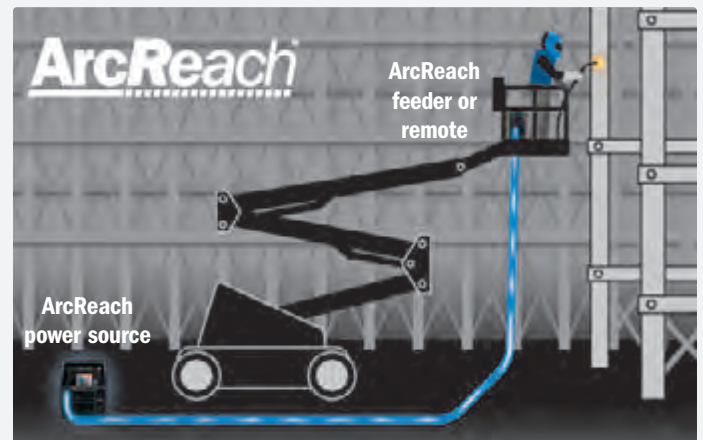

XMT® 450 CC/CV ArcReach®

See literature DC/18.94



Note: XMT 450 CC/CV ArcReach does not support the Cable Length Compensation (CLC™) and Adjust While Welding (AWW™) features or the ArcReach Smart Feeder.

Auto-Process Select™ System automatically changes to MIG/FCAW (with gas) if electrode positive polarity is detected or FCAW (no gas) if electrode negative polarity is detected, when ArcReach communication is established between the feeder and the XMT – reducing the need to access the power supply.

Automatic return to panel settings. System automatically returns to XMT setting when ArcReach communication is terminated. For example, if the XMT is set to gouging at 550 amps and an ArcReach feeder is connected, the XMT will go to a MIG/FCAW process. If the feeder is disconnected, the XMT will go back to its previous setting (gouging at 550 amps).

Auto-Bind™ automatically establishes exclusive communication between the power source and the wire feeder, using the existing weld cables upon system power up.

Operator can precisely set arc voltage at the feeder and monitor the actual arc voltage and current delivered to the weld using the digital meters on the feeder. This removes guesswork when it comes to adhering to weld procedures.

Remote override of XMT. When an ArcReach feeder is connected to an XMT 450 ArcReach the feeder has full control and the XMT controls are disabled, preventing accidental changes by personnel other than the welding operator.

XMT Racks

All the benefits of an individual XMT in an easy-to-transport package for multiple arcs in the field.



XMT 350 FieldPro Rack shown.

Flexible solution. The flexibility of the XMT makes it ideal for multiple system racks. Every system in a rack can be used for different tasks on-site, increasing fleet utilization and making the best use of equipment budgets.

Easy installation. The power distribution system on the rack allows the entire rack to be wired into a single power drop, isolating high-voltage power in the field.

Model	Stock Number	Input Power to Rack
XMT 350 FieldPro	4-Pack Rack (907739) 6-Pack Rack (907740)	230-575 V, three-phase. (Fused for 460/575 V)
XMT 350 FieldPro Polarity Reversing	4-Pack Rack (907742) 6-Pack Rack (907741)	230-575 V, three-phase. (Fused for 460/575 V)
XMT 450 CC/CV ArcReach	4-Pack Rack (907700)	230/460 V, three-phase. (Fused for 460 V)
Empty Rack	(300970)	

*Optional 115-volt auxiliary power provides 10 amps of circuit-breaker protected power for coolant systems, etc.

**Duty cycle rating below achieved with 6-gauge input power cord (8-gauge cord supplied with unit).

Heavy Industrial  **DC 3 1** XMT 450
Phase Phase is 3-phase only.

Processes

- MIG (GMAW) • Stick (SMAW)
 - TIG (GTAW) • Flux-cored (FCAW)
 - RMD* • Pulsed MIG (GMAW-P)*
 - Air carbon arc cutting and gouging (CAC-A) (carbons – 304: 6.4 mm [1/4 in.], 350: 6.4 mm [1/4 in.], 450: 7.9 mm [5/16 in.])
- *XMT 350 FieldPro only with ArcReach Smart Feeder.

Stick/TIG

- XMT 350 FieldPro power source
- ArcReach Stick/TIG Remote

MIG/flux-cored

- XMT 350 FieldPro power source
- ArcReach SuitCase 12 feeder and Bernard® BTB Gun 300 A

RMD/pulse

- XMT 350 FieldPro power source
- ArcReach Smart Feeder and Bernard® PipeWorx 300-15 MIG gun

Most popular accessories

- XR-AlumaFeed® SuitCase® 301567
- SuitCase® Feeders
- ArcReach® Smart Feeder (for XMT 350 FieldPro power sources only)
- 20 and 70 Series Feeders
- Spoolmatic®/WC-24
- XR™S Control
- ArcReach® Stick/TIG Remote 301325 (Tweco®)
- ArcReach® Stick/TIG Remote with Polarity Reversing 300934 (Tweco®), 301176 (Dinse) (for XMT 350 FieldPro with Polarity Reversing power source only)
- Dinse 70 Series 134460 Male, 136600 Female
- **ArcReach® Heater** (for XMT 350 FieldPro power sources only)



	Model/Stock Number	Input Power	Amperage/Voltage Ranges	IP Rating	Rated Output	Amps Input at Rated Load Output, 60 Hz	Max. Open-Circuit Voltage	Dimensions	Net Weight
						208 V 230 V 400 V 460 V 575 V KVA KW			
350 A	XMT 350 FieldPro Power Source only (907730) 208-575 V with Tweco® (907730002) 208-575 V with Dinse (907730001) 208-400 V with Dinse, CE	3-phase	5-425 A 10-38 V	IP23	350 A at 34 VDC, 60% duty cycle	40.4 36.1 20.6 17.8 14.1 14.2 13.6	75 VDC	H: 432 mm (17 in.) W: 318 mm (12.5 in.) D: 610 mm (24 in.)	42.2 kg (93 lb.)
		1-phase	5-425 A 10-38 V		300 A at 32 VDC, 60% duty cycle**	60.8 54.6 29.7 24.5 19.9 11.7 11.2			
	XMT 350 FieldPro with Polarity Reversing Power Source only (907731) 208-575 V with Tweco® (907731002) 208-575 V with Dinse (907731001) 208-400 V with Dinse, CE	3-phase	5-425 A 10-38 V	IP23	350 A at 34 VDC, 60% duty cycle	40.4 36.1 20.6 17.8 14.1 14.2 13.6	75 VDC	H: 432 mm (17 in.) W: 318 mm (12.5 in.) D: 610 mm (24 in.)	42.2 kg (93 lb.)
		1-phase	5-425 A 10-38 V		300 A at 32 VDC, 60% duty cycle**	60.8 54.6 29.7 24.5 19.9 11.7 11.2			
450 A	XMT 450 CC/CV ArcReach (1/2 in. stud) (907481003) 230/460 V (907481004) 230/460 V w/auxiliary power*	3-phase	15-600 A 10-38 V	IP23	450 A at 38 VDC, 100% duty cycle	– 51 – 27.6 24.4 22 18.9	90 VDC	H: 438 mm (17.25 in.) W: 368 mm (14.5 in.) D: 689 mm (27.125 in.)	55.3 kg (122 lb.)

Wire Feeder Model/Stock Number	Input Power	Input Welding Circuit Rating	Wire Feed Speed	Wire Diameter Type and Capacity	Maximum Spool Size Capacity	Dimensions	Net Weight
ArcReach Suitcase 8 (301457) Tweco®, CE	Operates on open-circuit voltage and arc voltage: 14-48 VDC/110 max. OCV	330 A at 60% duty cycle	1.3-19.8 mpm (50-780 ipm) dependent on arc voltage	Solid wire 0.6-1.4 mm (.023-.052 in.) Flux-cored 0.8-2.0 mm (.030-5/64 in.)	203 mm (8 in.), 6.4 kg (14 lb.)	H: 324 mm (12.75 in.) W: 184 mm (7.25 in.) D: 457 mm (18 in.)	13 kg (28 lb.)
ArcReach Suitcase 12 (301456) Tweco®, CE	Operates on open-circuit voltage and arc voltage: 14-48 VDC/110 max. OCV	425 A at 60% duty cycle	1.3-19.8 mpm (50-780 ipm) dependent on arc voltage	Solid wire 0.6-1.4 mm (.023-.052 in.) Flux-cored 0.8-2.0 mm (.030-5/64 in.)	305 mm (12 in.), 20 kg (45 lb.)	H: 394 mm (15.5 in.) W: 229 mm (9 in.) D: 533 mm (21 in.)	15.9 kg (35 lb.)
FieldPro Smart Feeder (301177) Dinse, CE (300935) Tweco® (300935002) Tweco® w/flowmeter	Operates on open-circuit voltage and arc voltage: 14-48 VDC/110 max. OCV*	275 A at 60% duty cycle	50-500 ipm (1.3-12.7 mpm) dependent on arc voltage	.035-.045 in. (0.9-1.1 mm)	305 mm (12 in.), 15 kg (33 lb.)	H: 457 mm (18 in.) W: 330 mm (13 in.) D: 546 mm (21.5 in.)	23 kg (50 lb.)

Dimension™ 650 and 650 ArcReach®

See literature DC/19.3

Developed for harsh environmental conditions and output requirements that range from power-intensive to precise.



Dimension 650 ArcReach power source shown with ArcReach SuitCase 12 feeder and ArcReach Stick/TIG Remote (all sold separately).

ArcReach®

Every year, outdated welding equipment wastes hundreds of productive work hours – and thousands of dollars in profit – by forcing operators to make numerous walks from the weld joint to the welder. Welding systems with ArcReach technology let operators adjust welding parameters right at the weld joint without a control cord using the wire feeder or remote – maximizing arc-on time, improving safety and impacting the bottom line. **Don't walk. Weld!** Learn more at MillerWelds.com/arcreach

Note: Dimension 650 ArcReach does not support the new Cable Length Compensation (CLC™) and Adjust While Welding (AWW™) features or the ArcReach Smart Feeder.

All aluminum construction helps the machine resist corrosion for long life.

Exclusive protection input inductor protects machine's performance and reliability from "dirty" input power.

Wind Tunnel Technology™ protects internal components, greatly improving reliability.

Fan-On-Demand™ reduces power consumption and improves reliability.

High-quality performance in all welding processes, from thick to thin metals.

Arc control available in the stick and wire modes for easier fine tuning of tough-to-weld materials and out-of-position applications.

Reduced size and weight results in an easier-to-handle package that exceeds the welding performance of larger, heavier machines. Dimension 650 is 3.5 times lighter than the Dimension 652 and also uses 40 percent less floor space.

High electrical efficiency and excellent power factor mean that you can get more welding done using less power. Dimension 650 uses 32 percent fewer amps than the Dimension 652.

Heavy industrial   

Processes

- MIG (GMAW) ▪ Flux-cored (FCAW)
- Stick (SMAW) ▪ TIG (GTAW)
- Submerged arc (SAW)
- Air carbon arc cutting and gouging (CAC-A) (9.5 mm [3/8 in.] carbons)

Most popular accessories



- **Dimension 650 ArcReach Rack** 907701 4-pack rack
Rack comes assembled with four Dimension 650 ArcReach power sources fused for 460 V.
- ArcReach® SuitCase® Feeders
8 301457
12 301456
- SuitCase®12RC 301121
- 70 Series Feeders
- ArcReach Stick/TIG Remote 301325 (Tweco®)
- Bernard™ MIG Guns
- Running Gear Cylinder Rack 300408
- Industrial MIG 4/0 Kit (with lug connectors) 300390
- Extension Cables
242208025 7.6 m (25 ft.)
242208050 15 m (50 ft.)
242208080 24.4 m (80 ft.)

Model/Stock Number	Amperage/ Voltage Ranges	Rated Output	IP Rating	Amps Input at Rated Output, 50/60 Hz				Max. Open-Circuit Voltage	Power Source Dimensions (Includes lift eye)	Power Source Net Weight
				380 V	460 V	KVA	KW			
Dimension 650 (907617) 380/460 V power source only (907618) 380/400 V, CE Dimension 650 ArcReach (907617001) 380/460 V power source only	CC mode: 10–815 A CV mode: 10–44 V SAW mode: 10–65 V	650 A at 44 VDC, 100% duty cycle	IP23	53.2	42.8	34	30.7	87 VDC	H: 716 mm (28.187 in.) W: 424 mm (16.687 in.) D: 803 mm (31.625 in.)	71.7 kg (158 lb.)

DONT WALK WELD™

ArcReach® WELDING SYSTEMS

The more they walk
the more it costs.



ARCREACH PLUG-IN POWER SOURCES

XMT® 350 FieldPro™ Systems

Exceptional arc performance maximizes weld quality, minimizes defects.

XMT® 350 FieldPro™ Systems with Polarity Reversing

Provides outstanding stick and TIG performance for pipe welding, including automatic polarity selection.

XMT® 450 CC/CV ArcReach®*

Portability and excellent arc performance with flexibility and simplicity.

Dimension™ 650 ArcReach®*

For harsh environments and a wide range of output requirements.



ARCREACH ENGINE-DRIVEN POWER SOURCES

Trailblazer® 325 ArcReach® Models**

Unbeatable arc performance with superior runtimes and increased fuel efficiency.

Big Blue® ArcReach® Models**

Tackle tough jobs that require high output for welding, gouging and aux power.



ARCREACH WIRE FEEDERS

ArcReach® SuitCase® Feeders

For all ArcReach power sources. For MIG and flux-cored welding. Features remote voltage control and Auto-Process Select™.

ArcReach® Smart Feeder

For both XMT 350 FieldPro models and all ArcReach engine drives. For RMD® and pulsed MIG welding up to 61 m (200 ft.) from the power source.



ARCREACH STICK/TIG REMOTES

ArcReach® Stick/TIG Remote 301325

For all ArcReach power sources except XMT 350 FieldPro with Polarity Reversing. Features remote amperage control, arc control for stick and Auto-Process Select.

ArcReach® Stick/TIG Remote with Polarity Reversing 300934

For XMT 350 FieldPro with Polarity Reversing power source only. Provides remote control functionality of the XMT 350 FieldPro with Polarity Reversing hundreds of feet from the power source, including process changeover and amperage adjustment — with no special cables.

ArcReach® HEATING SYSTEMS

Allows economical,
insourced weld preheating.



ARCREACH HEATER AIR-COOLED INDUCTION SYSTEM

ArcReach® Heater and Tools

For all ArcReach power sources except XMT 450 CC/CV ArcReach.***

Designed for preheating and bakeout applications up to 600 degrees Fahrenheit. Induction heating tools (air-cooled cables or air-cooled quick wraps) connect to the heater which is powered by an ArcReach power source.

*Does not support the Cable Length Compensation (CLC) and Adjust While Welding (AWW) features or the ArcReach Smart Feeder.

**Does not support the Cable Length Compensation (CLC) and Adjust While Welding (AWW) features.

***ONLY Dimension 650 machines manufactured after 3/16/2021 are compatible. Compatible models have  on faceplate.

NEWSLETTERS DELIVERED RIGHT TO YOUR INBOX

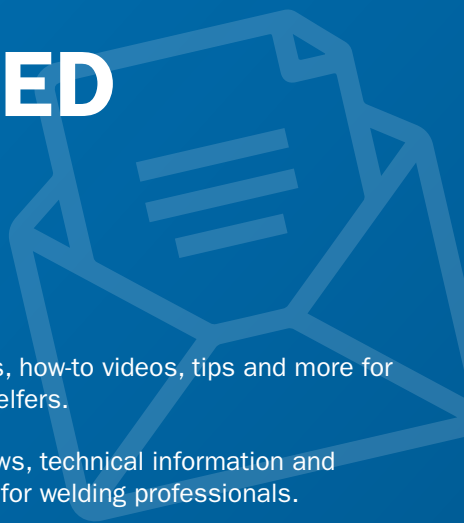

DIY – Project ideas, how-to videos, tips and more for welding do-it-yourselfers.

PRO – Industry news, technical information and application videos for welding professionals.

THE BEVEL – Success stories, resources and events for pipe, construction and fabrication professionals.

SAFETY – Regulatory updates, industry news and solutions for occupational health and safety professionals.



INSTRUCTOR – Classroom resources, safety tips and school spotlights for welding instructors.

alumaNATION – Tips, projects and technical information for anyone who welds aluminum.



Sign up now at
MillerWelds.com/newsletters



PIPE WELDING PODCAST: BEVEL TALK

Stay up to date on the latest news and trends in pipe welding. Educational and entertaining, BEVEL TALK features exciting dialogues and unique perspectives from elite professionals in the pipe welding industry.

Check out the podcast at
MillerWelds.com/beveltalk



PipeWorx 400 Welding System

See literature PWS/2.0

Optimized for pipe fabrication shops.

PipeWorx 400 welding system shown. Filler metal and shielding gas sold separately.



Simple process setup

- The front panel was designed by welders for welders
- Requires just a few basic steps to set up a new weld process, resulting in less training time and minimizing errors from incorrect setups
- Memory feature stores four programs for each selection: stick, DC TIG, and MIG (left and right side of feeder) — eliminates the need to remember parameters

True multiprocess machine

- Weld processes are optimized to deliver superior arc performance and stability specifically for root, fill, and cap passes on pipe
- RMD® and pulsed MIG increase quality and productivity

Quick process changeover

- Simply push a process selection button to choose a welding process
- Eliminates set-up time and reduces the risk of weld reworks due to incorrect cable connections
- PipeWorx “Quick Select” technology automatically selects the welding process, the correct polarity, cable outputs, gas solenoid, and user-programmed welding parameters

Single-system design

- One machine designed to perform all of your pipe welding needs
- Simplified and optimized specifically for pipe welding

Heavy Industrial   

Processes

- Stick (SMAW) ▪ DC TIG (GTAW)
- MIG (GMAW) ▪ Flux-cored (FCAW)
- RMD ▪ Pulsed MIG (GMAW-P)
- Air carbon arc cutting and gouging (CAC-A)

PipeWorx system includes (sold separately)

- PipeWorx 400 power source with cable hangers (907534)
- Dual feeder with drive rolls (300949)
- Two 4.6 m (15 ft.) PipeWorx 300 guns (195400)
- Running gear with gas cylinder rack and handles (300368)
- Cable kit with 7.6 m (25 ft.) work sense lead (300367)

Most popular accessories

- Bernard™ PipeWorx™ Guns
195399 4.6 m (15 ft.) 250-15
195400 4.6 m (15 ft.) 300-15



- PipeWorx 400 Insight Module 301304
- Composite Cable Kit
300454 7.6 m (25 ft.)
300456 15.2 m (50 ft.)
- PipeWorx Cooler 300370
- Foot Control Bracket 300676
- DSS-9 Dual Schedule Switch 071833
- RFCS-14 HD 194744

Advanced Technologies of PipeWorx FieldPro System

RMD® (regulated metal deposition)

- Higher quality root pass
- Calm stable arc
- Less spatter
- More tolerant of hi-lo conditions
- Reduced training requirements
- Less chance of cold lap or lack of fusion reducing rework
- Can eliminate the need for a hot pass
- Can eliminate backing/purge gas in some stainless applications



RMD carbon steel

Pulsed MIG

- Less heat input than traditional spray pulse transfer
- Shorter arc length
- Narrower arc cone
- Improved fusion and fill at the toes of the weld resulting in:
 - Faster travel speeds
 - Higher deposition rates
- Less training time required because pulsed MIG:
 - Virtually eliminates arc wander
 - Is easier to control the puddle
 - Compensates for tip to work variations automatically
- When used with RMD, it is possible to use one wire and one gas for all passes



Pulsed MIG stainless

PipeWorx Memory Card, Accu-Power 300667

Displays instantaneous power during welding to meet the ASME requirement for calculating heat input on complex waveform processes (RMD and pulsed MIG).

Power Source/ Stock Number	Welding Mode/Process	Amperage/ Voltage Ranges	Rated Output at 100% Duty Cycle	Amps Input at Rated Output, 50/60 Hz 380 V 400 V	KVA 380 V 400 V	KW 380 V 400 V	Max. Open- Circuit Voltage	Dimensions	Net Weight
PipeWorx 400 (907382) 230/460 V (907534) 380/400 V, CE	CC: Stick	40-400 A	400 A at 36 VDC	26.3 25.5	17.6 17.8	16.5 16.5	90 VDC	H: 724 mm (28.5 in.) W: 495 mm (19.5 in.) D: 806 mm (31.75 in.)	102 kg (225 lb.)
	CC/DC: TIG	10-350 A	350 A at 24 VDC	19 18.1	12.4 12.5	9.7 9.8			
	CV: MIG/flux-cored	10-44 V	400 A at 34 VDC	27.1 25.7	18.0 18.0	15.5 15.6			
Wire Feeder/Stock Number	Input Power	Input Welding Circuit Rating	Wire Feed Speed	Wire Diameter Capacity	Maximum Spool Size Capacity	Dimensions	Net Weight		
PipeWorx Dual Feeder (300366) (300950), CE	24 VAC, 11 A	100 V, 750 A at 100% duty cycle	1.3-19.8 m/min. (50-780 ipm)	0.9-1.6 mm (.035-.062 in.)	27 kg (60 lb.)	H: 356 mm (14 in.) W: 483 mm (19 in.) D: 737 mm (29 in.)	41 kg (90 lb.)		

Miller recommends



ITW Orbital Cutting & Welding

Applications, e.g.

pharmaceutical, biotechnology & chemical industry

« orbital (TIG) welding power sources and orbital welding heads »

food & beverage industry

pipe cutting & beveling machines

semiconductor industry

tube facing machines

aerospace industry

heating, ventilation & air conditioning industry

pipe end prep machines

power generation industry

The ITW ORBITAL CUTTING & WELDING division with its brands ORBITALUM TOOLS and E.H. WACHS provides global customers one source for the finest in pipe & tube cutting, beveling and orbital welding products.

WORLDWIDE SALES & SERVICE:



EUROPE, ASIA, AFRICA & MIDDLE EAST:

Orbitalum Tools GmbH
 Josef-Schuetzler-Str. 17
 78224 Singen, Germany
 Tel. +49 (0) 77 31-792 0
 tools@orbitalum.com
 www.orbitalum.com



NORTH AMERICA:

E.H. Wachs
 600 Knightsbridge Parkway
 Lincolnshire, IL 60069, USA
 Tel. +1 847 537 8800
 Toll Free 800 323 8185
 sales@ehwachs.com
 www.ehwachs.com

Product Guide

	Class	Stick	DC TIG	CAC-A	Portability	Weldable Metals	Welding Amperage Range	Special Features	Typical Applications
1-Phase	Thunderbolt® 160	●	●		Handle, shoulder strap	Steel, stainless	20-160 DC	Infinite amperage control, dual-voltage MVP™ plugs	Garage/job shops, maintenance/repair, farm
	Thunderbolt® 210	●	●				25-210 DC	Infinite amperage control	Garage/job shops, maintenance/repair, farm
	Maxstar® 161 S	●	●		Handle/shoulder strap, optional case		20-160 DC	Auto-Line™ (120-240 V), digital meter	MRO, ship installation/repair, farm/ranch
1- & 3-Ph	Maxstar® 210 STR	●	●	●	Handles, shoulder strap, optional carts	Steel, stainless	5-210 DC	Auto-Line™ (120-480 V), digital meters	Construction, fabrication, pipe, steel erection, shipbuilding
	CST™ 282	●	●	●	Handle, optional cart		5-280 DC	Portable at 41 lb., optional meter, also available in multioperator rack	Construction, fabrication, pipe, steel erection, shipbuilding
3-Ph	CST™ 282 Rack	●	●	●	5/16" Lift eye, optional running gear	Steel, stainless	5-280 DC	Up to 4 or 8 operators, lightweight	Construction, maintenance/repair, shipbuilding

Product Key

Class: ● Light industrial ● Industrial ● Heavy industrial Capability: ● Designed for this process ● Capable of this process
 *Two machines paralleled.

Thunderbolt® 160 and 210

See literature DC/37.0

Dependable, portable, powerful stick welder.



Thunderbolt 160 shown.

Nearly 45 kg (100 lb.) lighter so you can work smarter not harder by bringing the welder to the work.

More powerful – up to 85 more amps – compared to leading competitive machine means you can weld thicker materials.

Hot Start™ technology provides easy, quick and reliable arc starts.



Thunderbolt 160 includes multi-voltage plug (MVP™)

which allows for connection to 120- or 240-volt receptacles without tools. Choose the plug that fits the receptacle and connect it to the power cord.

Light industrial ● CC DC 1 Phase

Process - Stick (SMAW)

Comes complete with

- 3 m (10 ft.) No. 4 electrode cable with heavy-duty electrode holder
- 3 m (10 ft.) work cable with clamp
- 2 m (6.5 ft.) power cord with MVP™ plugs for 120 V and 240 V (160 model) OR standard 240 V plug (210 model)
- Cable pouch

Model/Stock Number	Input Power	Welding Amperage Range	Rated Output	Amps Input at Rated Output	Max. Open-Circuit Voltage	Dimensions	Net Weight
Thunderbolt 160 (907721)	120 V	20-80	65 A at 20% duty cycle	20.7	91 VDC	H: 267 mm (10.5 in.) W: 181 mm (7.125 in.) D: 340 mm (13.375 in.)	6.8 kg (15 lb.)
	240 V	20-160	160 A at 30% duty cycle	27.8	91 VDC		
Thunderbolt 210 (907722)	240 V	25-210	210 A at 20% duty cycle	43.4	85 VDC		7.0 kg (15.5 lb.)

Maxstar® 161 S

See literature DC/27.3

Industrial class – provides maximum portability and performance in the most compact stick package in the industry.



Maxstar 161 S with X-CASE shown.



Allows for any input voltage hookup (120-240 V) with no manual linking, providing convenience in any job setting. Ideal solution for dirty or unreliable power.

Portable with adjustable handle/shoulder strap. Easy to transport at only 5.9 kg (13 lb.).

Fan-On-Demand™ power source cooling system operates only when needed, reducing noise, energy use and the amount of contaminants pulled through the machine.

Digital meter for more precise control when presetting or monitoring welding amperage.

Adaptive Hot Start™ for stick arc starts.

Stick-Stuck detects if the electrode is stuck to the part and turns the welding output off to safely and easily remove the electrode. Menu selectable.

Superior stick arc performance even on the difficult-to-run electrodes like E6010.

Industrial ● CC DC 1 Phase

Process - Stick (SMAW)

Comes complete with

- 2 m (6.5 ft.) power cords for 120 V and 240 V
- 4 m (13 ft.) electrode cable with holder and 25 mm Dinse-style connector
- 3 m (10 ft.) work cable with clamp and 25 mm Dinse-style connector
- Quick-reference guide

907709001 includes above plus

- Protective X-CASE™

Most popular accessories

- Protective X-CASE™ 301429

Stock Number	Input Power	Welding Amperage Range	Rated Output	Amps Input at Rated Output, 50/60 Hz	KVA at Duty Cycle	KW	Max. Open-Circuit Voltage	Dimensions	Net Weight
(907709) (907709001) with X-CASE	120 V	20-90	90 A at 23.6 V, 30% duty cycle	23.2	2.8	2.8	48 VDC (12-16 VDC*)	H: 262 mm (10.3 in.) W: 142 mm (5.6 in.) D: 343 mm (13.5 in.)	5.9 kg (13 lb.)
	240 V	20-160	160 A at 26.4 V, 20% duty cycle	22.6	5.4	5.3			

Maxstar® 210 STR See literature DC/32.1

Maximum flexibility with automatic connection to any input power while maintaining the best DC stick/TIG welding performance in its product class.



AUTO-LINE TECHNOLOGY Allows for any input voltage hook-up (120–480 V) with no manual linking, providing convenience in any job setting. Ideal solution for dirty or unreliable power.

Lift-Arc™ provides TIG arc initiation without the use of high frequency.

Dual schedule allows operators to switch between welding parameters for specific electrodes without readjusting the machine.

Hot Start™ adaptive control provides positive arc starts without sticking.

Fan-On-Demand™ power source cooling system operates only when needed, reducing noise, energy use and the amount of contaminants pulled through the machine.

Remote amperage control.

Digital meters for more precise control when presetting or monitoring welding amperage.

Portable with adjustable shoulder strap.

Industrial **CC DC 3 1**
Phase Phase

Processes

- Stick (SMAW) • TIG (GTAW)

Comes complete with

- 2.4 m (8 ft.) power cord (no plug)
- Two 50 mm Dinse-style connectors

Most popular accessories

- 3.8 m (12.5 ft.) Weldcraft™ A-150 Valve TIG torch WP-17V-25-2
- Remote Controls
- Air-Cooled TIG Torch Connector

**Sense voltage for stick and Lift-Arc TIG.*

Stock Number (907682)	Welding Process	Input Power	Welding Amperage Range	Rated Output	Phase	Amps Input at Rated Load Output, 50/60 Hz						Max. Open-Circuit Voltage	Dimensions	Net Weight	
						120 V	208 V	240 V	400 V	480 V	KVA				KW
	Stick	208–480 V	5–210	160 A at 26.4 V, 60% duty cycle	Three-phase	–	15	13	8	6	5.5	5.2	80 VDC (11 VDC*)	H: 346 mm (13.6 in.) W: 219 mm (8.6 in.) D: 495 mm (19.5 in.)	16.3 kg (36 lb.)
					Single-phase	–	26	22	13	11	5.3	5.3			
	120 V	5–100	90 A at 23.6 V, 60% duty cycle	Single-phase	23	–	–	–	–	2.8	2.8				
	TIG	208–480 V	1–210	210 A at 18.4 V, 60% duty cycle	Three-phase	–	14	12	7	6	5.2	4.9			
Single-phase					–	24	20	12	10	4.9	4.9				
120 V					1–210	125 A at 15 V, 60% duty cycle	Single-phase	22	–	–	–	–	2.6	2.6	



CST™ 282 See literature DC/29.6

Durable power source designed for the construction industry. Ideal for stick electrodes up to 4.8 mm (3/16 in.) and TIG welding of pipe and plate.



CST 282 with Tweco®-style receptacles shown.

Superior stick arc performance even on the difficult-to-run electrodes like E6010.

AUTO-LINE TECHNOLOGY For portability and reliability, Auto-Line allows for any input voltage hookup (208–575 V, single- or three-phase) with no manual linking, providing convenience in any job setting. Ideal solution for dirty or unreliable power.

Digital meter for more precise control when presetting or monitoring welding amperage.

Portable in the shop or at the jobsite – at 15.7 kg (34.6 lb.) the CST 282 is easily moved from location to location.

Lift-Arc™ provides TIG arc initiation without the use of high frequency.

Universal connector system allows the machine to be quickly configured to either Tweco®, Dinse- or Cam-Lok™-style receptacles. Extra receptacles and wrench are sold separately as Universal Connector Kits.



Industrial ● **CC DC 3 1**
Phase Phase

Processes

- Stick (SMAW) ▪ TIG (GTAW)

Comes with

- 1.8 m (6 ft.) power cord

Most popular accessories

- CST 282 Rack (see below)
- Remote Controls
- Universal Connector Kits
 - 301611 Tweco-style receptacles
 - 301595 Dinse-style receptacles
 - 301637 Cam-Lok-style receptacles
- For TIG torches see literature DC/29.6

Stock Number (907770) Tweco® (907810) Dinse 208–575 V	Welding Process	Input Power	Welding Amperage Range	Rated Output	Amps Input at Rated Load Output, 50/60 Hz					KVA	KW	Max. Open-Circuit Voltage	Dimensions	Net Weight	
					208 V	230 V	400 V	460 V	575 V						
	Stick	Three-phase	30–280	280 A at 31.2 V, 35% duty cycle	29.63	26.65	15.71	13.92	12.08	12	10.2	103 VDC	H: 343 mm (13.5 in.) W: 203 mm (8 in.) D: 470 mm (18.5 in.)	15.7 kg (34.6 lb.)	
				200 A at 28 V, 100% duty cycle	18.86	17.09	10.6	9.37	8.02	8	6.4				
		Single-phase	30–280	200 A at 28 V, 50% duty cycle	33.7	30.65	17.61	16.18	14.51	8.3	6.6				
				150 A at 26 V, 100% duty cycle	23.07	20.59	12.97	11.8	11.15	6.4	4.5				
	TIG	Three-phase	5–280	280 A at 21.2 V, 35% duty cycle	20.77	18.85	11.54	10.22	8.95	8.9	7.1				9.5 VDC
				200 A at 18 V, 100% duty cycle	12.89	11.74	7.42	6.55	5.49	5.4	4.3				
	Single-phase	5–280	200 A at 18 V, 50% duty cycle	22.12	19.71	12.89	11.06	10.61	6.1	4.4					
			150 A at 16 V, 100% duty cycle	14.84	13.38	8.73	8.63	7.72	5.1	2.9					

CST™ 282 Racks See literature DC/29.6

Rugged enclosure provides simple means for protecting and transporting multiple welding power sources for construction, power plant turn-arounds and shipbuilding applications.

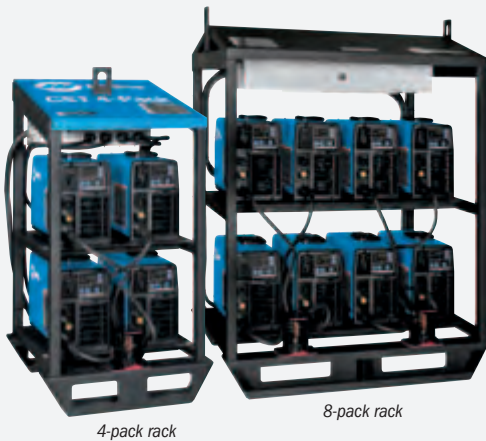

4-pack rack

8-pack rack



One easy connection allows up to eight inverters to be connected with one primary power drop.

All controls including power switch are located on front of machine for easy access.

Top cover protects machines from falling debris.

Lift eye(s) simplify crane or overhead lifting device transport.

Lift truck fork pockets.

Common output ground connection (for same polarity use only).

Racks include casters that can be bolted to the rack base. Two swivel casters and two non-swivel casters. Large 127 mm (5 in.) diameter wheels enable the rack to be moved over grating and driveway gravel.

Heavy industrial ● **CC DC 3**
Phase

Processes

- Stick (SMAW) ▪ TIG (GTAW)

Comes with

- Cables to connect power sources to common work connection
- 127 mm (5 in.) casters

Most popular accessories







- Remote Controls
- For TIG torches see literature DC/29.6

Model	Stock Number	Rack Capacity	Input Power to Rack	Amps Input at Rated Load Output, 50/60 Hz			KVA	KW	Dimensions (H x W x D) (Includes lift eye)	Net Weight
			230 V	460 V	575 V					
4-Pack Rack	(907811) Tweco®	4 units	208–575 V, three-phase, 50/60 Hz (fused for 460 V)	106.5	56	48.5	48	40.8	1,289 x 648 x 673 mm (50.75 x 25.5 x 26.5 in.)	150 kg (330 lb.)
8-Pack Rack	(907812) Tweco®	8 units		213	112	97	96	81.6	1,508 x 1,092 x 873 mm (59.38 x 43 x 34.38 in.)	250 kg (550 lb.)
Empty Rack	(301610)	8 units	–	–	–	–	–	Same as 8-pack rack above	127 kg (280 lb.)	

Miller recommends

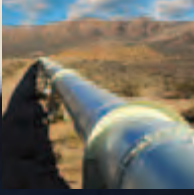

ITW Orbital Cutting & Welding

<p>Applications, e.g.</p>	<p>Portable weld prep machine tools for industrial applications, e.g.</p>
 <p>oil, gas & petrochemical industry</p>	<p>NEW DynaPrep MDSF split frames for heavy duty form tooling & pipe weld preparation</p>
 <p>power generation industry</p>	 <p>HDSF heavy duty split frames - built for big jobs in the field</p>
 <p>pipeline distribution</p>	 <p>TRAV-L-CUTTER portable milling machines</p>
 <p>off-shore</p>	 <p>LCSF low clearance split frames</p>
<p>SDB / FF small diameter bevelers & flange facers</p>	 <p>EP 424 ID mount end prep machines</p>

The ITW ORBITAL CUTTING & WELDING division with its brands E.H. WACHS and ORBITALUM TOOLS provides global customers one source for the finest in pipe & tube cutting, beveling and orbital welding products.

WORLDWIDE SALES & SERVICE:



NORTH AMERICA:

E.H. Wachs
 600 Knightsbridge Parkway
 Lincolnshire, IL 60069, USA
 Tel. +1 847 537 8800
 Toll Free 800 323 8185
 sales@ehwachs.com
 www.ehwachs.com



EUROPE, ASIA, AFRICA & MIDDLE EAST:

Orbitalum Tools GmbH
 Josef-Schweittler-Str. 17
 78224 Singen, Germany
 Tel. +49 (0) 77 31 - 792 0
 tools@orbitalum.com
 www.orbitalum.com



TIG GTAW

Also see Multiprocess section for machines that can TIG weld.

For more detailed information, visit



MillerWelds.com/tig



	Product Guide					Max. Electrode Diameter				Material Thickness Range (TIG)	Welding Amperage Range	Pulse Capability	Net Weight	Generator Power Requirement	
	Class	TIG	Pulsed TIG	Stick	CAC-A	E6010/11	E6013	E7018	E7024						CAC-A
DC (Steel)	Maxstar® 161	●	●	○	●										
	Maxstar® 210	●	●	○	●										
	Maxstar® 280	●	●	●	●										
	Maxstar® 400	●	●	●	●										
	Maxstar® 800	●	●	●	●										
AC/DC (Aluminum/Steel)	Diversion™ 180	●	●												
	Syncrowave® 210	●	●	●	●	○									
	Syncrowave® 300	●	●	●	●										
	Syncrowave® 400	●	●	●	●										
	Dynasty® 210	●	●	●	●										
	Dynasty® 280	●	●	●	●										
	Dynasty® 400	●	●	●	●										
	Dynasty® 800	●	●	●	●										

Product Key

Class: ● Light industrial ● Industrial ● Heavy industrial Capability: ● All models ○ Some models

Diversion™ 180 AC/DC TIG See literature AD/1.5

Professional-grade arc in a package designed specifically for personal users. Contains all of the features you need – simplicity combined with superior performance and value.



TIG Welding Capability

Max. 4.8 mm (3/16 in.)	Max. 4.8 mm (3/16 in.)
Steel	Aluminum
Min. 0.6 mm (0.025 in.)	Min. 0.75 mm (0.030 in.)



Multi-voltage plug (MVP™) allows for connection to 120- or 240-volt receptacles without tools. Choose the plug that fits the receptacle and connect it to the power cord.

Fan-On-Demand™ power source cooling system operates only when needed, reducing noise, energy use and the amount of contaminants pulled through the machine.

Auto-postflow adjusts the length of postflow time based on the amperage setting, shielding your tungsten and eliminating the need to set the postflow time.

Advanced squarewave AC provides a fast freezing weld puddle and deeper penetration.

Weldcraft™ A-150 torch with Diamond Grip™ provides more comfortable grip and reduces operator fatigue.

Easy-to-understand operator interface. Power up, select material type, set material thickness range and start welding!

Inverter-based AC/DC power source provides a more consistent welding arc while using less power.

HF arc starting for non-contact arc initiation that reduces tungsten and material contamination.

Portable. Easy to transport at 23 kg (50 lb.).

*While idling.

Light industrial  **CC** AC **1** DC Phase

Process - TIG (GTAW)

Comes with

- Power cord with MVP plugs for 120 V and 240 V
- 3.8 m (12.5 ft.) Weldcraft™ A-150 TIG torch
- 3.7 m (12 ft.) work cable with clamp
- RFCS-RJ45 remote foot control
- Flow gauge regulator with hose

Most popular accessories

- Running Gear/Cylinder Rack 301239
- Protective Cover 300579
- RCCS-RJ45 Remote Fingertip Control 301146
- RJ45 to 14-Pin Adapter Cord 300688
- Weldcraft™ Flexible Torch Body Kits (requires handle 105Z55R) A-125F (WP-9F) A-150F (WP-17F)
- TIG Torch Accessory Kit AK2C

AC/DC	Stock Number (907627)	Input Power	Welding Amp Range	Rated Output	Amps Input at Rated Output	KVA	KW	Max. Open-Circuit Voltage	Dimensions	Net Weight
			115 V	10-125	125 A at 15 V, 35% duty cycle	26.5 (.88*)	3.1 (.1*)	3.0 (.03*)	80 VDC	H: 433 mm (17 in.) W: 251 mm (9.875 in.) D: 608 mm (23.875 in.)
		230 V	10-180	150 A at 16 V, 20% duty cycle 180 A at 17.2 V, 10% duty cycle	16 (.44*) 20.5 (.44*)	3.7 (.1*) 4.7 (.1*)	3.6 (.03*) 4.6 (.03*)			

Maxstar® 161 STL and STH DC TIG and Stick See literature DC/27.5

DC/27.5

Maximum portability and performance provided in one compact TIG/stick package.



TIG Welding Capability

Max. 4.8 mm (3/16 in.)
Steel
Min. 0.5 mm (0.020 in.)

Two models available.

STL: DC TIG/stick with Lift-Arc™ starting without high frequency.
STH: DC TIG/stick with high frequency and Lift-Arc™ starting, plus built-in pulsing from 0-150 pulses per second.

AUTO-LINE TECHNOLOGY Allows for any input voltage hook-up (120-240 V) with no manual linking.

Portable with adjustable handle/shoulder strap. Easy to transport at only 5.9 kg (13 lb.).

Built-in gas solenoid eliminates need for a bulky torch with a gas valve.

Digital meter for more precise control.

Fan-On-Demand™ power source cooling system.

Superior stick arc performance even on the difficult-to-run electrodes like E6010.

Maxstar 161 STH TIG/stick package with remote fingertip control (907711001) shown – includes X-CASE.

*Sense voltage for stick and Lift-Arc™ TIG.

Light industrial  **CC** DC **1** Phase

Processes

- TIG (GTAW) ▪ Stick (SMAW)
- Pulsed TIG (GTAW-P) with STH model

Comes with

- 2 m (6.5 ft.) 120 V and 240 V power cords
- 4 m (13 ft.) electrode cable with holder and 25 mm Dinse-style connector
- 3 m (10 ft.) work cable with clamp and 25 mm Dinse-style connector
- Air-cooled TIG torch connector
- Quick-reference guide

TIG/stick packages include above plus

- 3.8 m (12.5 ft.) Weldcraft™ A-150 TIG torch (WP1712RDI25)
- Protective X-CASE™ (301429)
- Flow gauge regulator with hose
- AK2C TIG torch accessory kit
- RCCS-6M remote fingertip control (packages 907710002 and 907711001 only)

DC	Model/Stock Number	Model/Stock Number	Welding Process	Input Power	Welding Amp Range	Rated Output	Amps Input at Rated Output, 50/60 Hz	KVA at Duty Cycle	KW	Max. Open-Circuit Voltage	Dimensions	Net Weight
		Maxstar 161 STL (907710) Power source only (907710001) TIG/stick package (907710002) TIG/stick package with remote fingertip control	Maxstar 161 STH (907711) Power source only (907711001) TIG/stick package with remote fingertip control	TIG	120 V	5-130	130 A at 15.2 V, 30% duty cycle	22.6	2.73	2.70	48 VDC (12-16 VDC*)	H: 262 mm (10.3 in.) W: 142 mm (5.6 in.) D: 343 mm (13.5 in.)
				240 V	5-160	160 A at 16.4 V, 20% duty cycle	15.05	3.62	3.49			
			Stick	120 V	20-90	90 A at 23.6 V, 30% duty cycle	23.16	2.78	2.76			
				240 V	20-160	160 A at 26.4 V, 20% duty cycle	22.55	5.41	5.25			

Syncrowave® 210

AC/DC TIG, Stick and MIG (with Spool Gun)

See literature AD/4.6

Continuing the tradition of innovation through advanced inverter technology for light-industrial and personal users.



Easy to use.

- 1) Turn power on.
- 2) Select the process.
- 3) Set amperage or voltage based on material thickness.

Then weld! It's easy as 1,2,3.

TIG Welding Capability

Max. 6.4 mm (1/4 in.)

Steel	Aluminum
Min. 0.5 mm (0.020 in.)	

AUTO-LINE TECHNOLOGY Allows for any input voltage hook-up (120-240 V) with no manual linking, providing convenience in any job setting. Ideal solution for dirty or unreliable power.



Multi-voltage plug (MVP™) allows for connection to 120- or 240-volt receptacles without tools. Choose the plug that fits the receptacle and connect it to the power cord.

Low power draw. Inverter-based power source provides full welding output from 240 volts while drawing less than 30 amps.

Pro-Set™ (TIG/stick) eliminates the guesswork when setting weld parameters. Use Pro-Set when you want the speed, convenience and confidence of preset controls.

HF arc starting for non-contact arc initiation that reduces tungsten and material contamination.

AC frequency (TIG) controls the width of the arc cone and can improve directional control of the arc.

AC balance (TIG) control provides adjustable oxide removal which is essential for creating the highest quality aluminum welds.

Pulse (TIG). Pulsing can increase puddle agitation, arc stability and travel speeds while reducing heat input and distortion.

DIG (stick) control allows the arc characteristics to be changed for specific applications and electrodes. Lower the DIG setting for smooth running electrodes like E7018 and increase the DIG setting for stiffer, more penetrating electrodes like E6010.

Auto-Set™ (MIG) automatically sets your welder to the proper parameters. Simply set the wire size, material thickness, and shielding gas and you're ready to weld. (TIG/MIG complete package only.)

Light industrial ● CC AC 1 DC Phase

Processes

- AC/DC TIG (GTAW) ▪ DC stick (SMAW)
- Pulsed TIG (GTAW-P) ▪ MIG (GMAW)*
- Flux-cored (FCAW)*

*TIG/MIG Complete package only.

Comes with

- 3 m (10 ft.) power cord with MVP plugs for 120 V and 240 V
- 3.8 m (12.5 ft.) Weldcraft™ A-150 TIG torch (WP1712MFD150)
- 3.7 m (12 ft.) work cable with clamp and Dinse-style connector
- Electrode holder with Dinse-style connector
- RFCS-14 remote foot control
- Flow gauge regulator with hose
- Factory-installed running gear with EZ-Change™ low cylinder rack

Most popular accessories

- 7.6 m (25 ft.) Weldcraft™ A-150 TIG Torch WP-17-25-R
- Protective Cover 195142
- RCC-14 Remote Control 151086
- Wireless Remote Foot Control 300429
- TIG Torch Accessory Kit AK2C Includes one short back cap, one of each size (#4, #5, #6) alumina nozzle, and one of each size (1, 1.6, 2.4 mm [.040, 1/16, 3/32 in.]) of the following: collet, collet body, and 178 mm (7 in.) 2% ceriated tungsten electrode.
- TIG Torch Accessory Kit AK-150MFC Allows A-150 torch customization. Converts into 28 different torch styles while using existing cable. Includes collets, collet bodies, nozzles, torch heads, handle and more.
- Spoolmate™ 150 spool gun 301272

AC/DC	Stock Number	Input Power	Welding Process	Welding Amperage Range	Rated Output (R.M.S.)	Amps Input at Rated Output, 50/60 Hz	Max. Open-Circuit Voltage	Dimensions	Net Weight
	(907596) TIG/Stick System	115 V	DC TIG	5-125 A	95 A at 13.8 V, 60% duty cycle	17.4 (.58 while idling)	47 VDC	H: 800 mm (31.5 in.) W: 470 mm (18.5 in.) D: 1092 mm (43 in.)	Runner package: 61 kg (133.5 lb.) Runner TIG/MIG Complete package: 63 kg (139.5 lb.)
		AC TIG	5-125 A	90 A at 13.6 V, 60% duty cycle	12.4 (.58 while idling)				
		DC stick	20-90 A	70 A at 22.8 V, 60% duty cycle	20.5 (.58 while idling)				
	230 V	DC TIG	5-210 A	125 A at 15 V, 60% duty cycle	11.9 (.35 while idling)				
		AC TIG	5-210 A	114 A at 14.6 V, 60% duty cycle	8.62 (.35 while idling)				
		DC stick	20-150 A	90 A at 23.6 V, 60% duty cycle	11.9 (.35 while idling)				



Miller recommends



Bernard semi-automatic MIG guns and consumables have been used and trusted for decades by top companies in agriculture, shipbuilding and fabrication. This is why Miller not only recommends Bernard MIG guns but also pairs these guns with many of their industrial wire feeders and power sources.

For information on Bernard MIG gun options and for detailed technical support information, please visit **BernardWelds.com** or your local distributor to learn more.

Visit the **NEW! merged website** for
Bernard and Tregaskiss at Tregaskiss.com



Maximizing throughput. Minimizing costs.

Automated welding applications require flexible, repeatable solutions that **maximize production uptime and throughput while minimizing costs**. This is why industrial manufacturers rely on Tregaskiss and its proven track record of delivering **reliable and resilient robotic MIG welding guns and peripherals**.



Visit **Tregaskiss.com** for more information or to configure a robotic gun for your welding application today.

Syncrowave® 300 and 400

AC/DC TIG and Stick

See literature AD/4.25 (300) and AD/4.28 (400)



Syncrowave 300 machine only

Syncrowave 400 TIGRunner

TIG Welding Capability

400 Max. 15.9 mm (5/8 in.)	400 Max. 12.7 mm (1/2 in.)
300 Max. 1/2 in. (12.7 mm)	300 Max. 3/8 in. (9.5 mm)
Steel	Aluminum
Min. 0.3 mm (0.012 in.)	Min. 0.4 mm (0.015 in.)



Auto-Link® circuit automatically links the power source to primary voltage being applied (208/240/480 V, single- or three-phase).

AC balance control features adjustable cleaning action while increasing arc stability on various aluminum alloys, and helps eliminate tungsten spitting and arc rectification.

Blue Lightning™ high-frequency (HF) arc starter for non-contact arc initiation. Provides more consistent arc starts and greater reliability compared to traditional HF arc starters.

Lift-Arc™ provides AC or DC arc initiation without the use of high frequency.

Auto-postflow adjusts the length of postflow time based on the amperage setting, shielding your tungsten and eliminating the need to set the postflow time.

Pro-Set™ eliminates the guesswork when setting weld parameters. Use Pro-Set when you want the speed, convenience and confidence of preset controls.

Arc timer/cycle counter records actual welding time and number of arc starts. Great for estimating job costs.

Line voltage compensation keeps power source constant regardless of fluctuations in input power (± 10 percent).

Coolmate™ 3S cooler (shown in TIGRunner). Three-gallon cooling system features a flow indicator to visually indicate system is working and an external filter to stop objects from entering the water-cooled torch cable.

Industrial

Processes

- TIG (GTAW) ▪ Stick (SMAW)
- DC pulsed TIG (GTAW-P)

Comes with

- 3 m (10 ft.) power cord (no plug)
- Two 50 mm Dinse-style connectors

Most popular accessories

- Coolant 043810



- **Weldcraft™ Water-Cooled Torch Kits**
300990 W-280 (WP-280)
301268 W-375
- **Remote Controls**
043688 RCCS-14 fingertip control
194744 RFCS-14 HD foot control
301580 Wireless foot control

¹For Syncrowave 400 refer to owner's manual for 208 V output rating and duty cycle.

²Sense voltage for low OCV stick and Lift-Arc™ TIG.

³See literature AD/4.25 and AD/4.28 for Complete package dimensions and weight.

AC/DC	Model/Stock Number	Welding Process	Input Power	Welding Amp Range	Rated Output ¹	Amps Input at Rated Output, 50/60 Hz						Max. Open-Circuit Voltage	Power Source Dimensions ²	Power Source Net Weight ²	
						208 V	240 V	380 V	400 V	480 V	KVA				KW
AC/DC	Syncrowave 300 (907782) Power source only (907782001) TIGRunner (907782002) 380/400 V Power source only, CE (907782003) TIGRunner 380/400 V 50/60 Hz Power source/ Water cooler & Running gear, CE	TIG (includes cooler power draw)	3-phase	5-300	210 A at 18.4 V, 60% duty cycle	16	14	8.2	7.9	7	5.9	5.5	60 VDC (13 VDC ²)	H: 746 mm (29.4 in.) W: 381 mm (15 in.) D: 625 mm (24.6 in.)	45.8 kg (101 lb.)
			1-phase			27	24	—	—	12	5.7	5.5			
	Stick	3-phase	5-230	160 A at 26.4 V, 60% duty cycle	16	11	8.7	8.2	5	5.7	5.5				
		1-phase			27	23	—	—	11	5.7	5.5				
AC/DC	Syncrowave 400 (907783) Power source only (907783001) TIGRunner (907783002) 380/400 V Power source only, CE (907783003) TIGRunner 380/400 V 50/60 Hz Power source/ Water cooler & Running gear, CE	TIG (includes cooler power draw)	3-phase	5-400	300 A at 22 V, 60% duty cycle	25	23	13.7	12.4	11	9.1	8.8	70 VDC (13 VDC ²)	H: 746 mm (29.4 in.) W: 381 mm (15 in.) D: 625 mm (24.6 in.)	59.4 kg (131 lb.)
			1-phase			43	42	—	—	20	9.7	8.9			
	Stick	3-phase	5-300	250 A at 30 V, 60% duty cycle	27	24	14.7	13.3	12	9.8	9.4				
		1-phase			47	43	—	—	21	10.4	9.5				

Maxstar® and Dynasty® 210/280 Series DC (Maxstar) and AC/DC (Dynasty) TIG and Stick

See literature DC/32.1 (Maxstar 210), DC/35.0 (Maxstar 280), AD/4.81 (Dynasty 210) and AD/4.9 (Dynasty 280)



Maxstar 210 Series
(Maxstar 210 shown).

Dynasty 280 DX



210 Series TIG Welding Capability

Max. 6.4 mm (1/4 in.)	Max. 6.4 mm (1/4 in.)
Steel	Aluminum (Dynasty only)
Min. 0.05 mm (0.002 in.)	Min. 0.3 mm (0.012 in.)

280 Series TIG Welding Capability

Max. 9.5 mm (3/8 in.)	Max. 9.5 mm (3/8 in.)
Steel	Aluminum (Dynasty only)
Min. 0.1 mm (0.004 in.)	Min. 0.3 mm (0.012 in.)

Base and DX models available. Base model provides essential TIG and stick functions. DX model adds extended ranges to sequencer, full trigger options, and full preflow and pulser functions.

Note: See the Multiprocess section for the Maxstar 280 Multiprocess and Dynasty 280 DX Multiprocess, and see the Stick section for the Maxstar 210 STR.

AUTO-LINE TECHNOLOGY Allows for any input voltage hookup (210 models: 120–480 V, 280 models: 208–575 V) with no manual linking, providing convenience in any job setting. Ideal solution for dirty or unreliable power.

Blue Lightning™ high-frequency (HF) arc starter for non-contact arc initiation. Provides more consistent arc starts and greater reliability compared to traditional HF arc starters.

Lift-Arc™ provides AC or DC arc initiation without the use of high frequency.

Hot Start™ adaptive control provides positive arc starts without sticking.

Auto-postflow adjusts the length of postflow time based on the amperage setting, shielding your tungsten and eliminating the need to set the postflow time.

Pro-Set™ eliminates the guesswork when setting weld parameters. Use Pro-Set when you want the speed, convenience and confidence of preset controls. Simply select the feature and adjust until Pro-Set appears on the display.

Sleep timer conserves electricity. This programmable feature will power down the machine if it sits idle for a specified time.

Update and expand. Front panel memory card data port provides the ability to easily update software and expand product features.

Optional cooler power supply (CPS) is an integrated 120-volt dedicated-use receptacle for the Coolmate™ 1.3. *Not available on Maxstar 210 Series.*

Cooler-On-Demand™ feature operates the auxiliary cooling system only when needed. Reduces noise, energy use, and airborne contaminants pulled through the cooler. *Only available on CPS models.*

*Refer to owner's manual for 208-volt output ratings and duty cycle.
**Sense voltage for low OCV stick and Lift-Arc™ TIG.

Model/ Stock Number	Welding Process	Input Power	Welding Amp Range	IP Rating	Rated Output at 60% Duty Cycle	Amps Input at Rated Load Output, 50/60 Hz								Max. Open- Circuit Voltage	Dimensions	Net Weight		
						120 V	208 V	230 V	240 V	400 V	460 V	480 V	575 V				KVA	KW
Maxstar 210 (907683) Maxstar 210 DX (907684) (907684001), CE	TIG	3-phase	1-210	IP23	210 A at 18.4 V	–	14	–	12	7	–	6	–	5.2	4.9	80 VDC (11 VDC**)	H: 346 mm (13.6 in.) W: 219 mm (8.6 in.) D: 495 mm (19.5 in.)	17.2 kg (38 lb.)
		1-phase	1-210		210 A at 18.4 V	–	24	–	20	12	–	10	–	4.9	4.9			
	Stick	1-phase (120 V)	1-150	125 A at 15 V	22	–	–	–	–	–	–	–	–	2.6	2.6			
		3-phase	5-210	160 A at 26.4 V	–	15	–	13	8	–	6	–	5.5	5.2				
		1-phase	5-210	160 A at 26.4 V	–	26	–	22	13	–	11	–	5.3	5.3				
		1-phase (120 V)	5-100	90 A at 23.6 V	23	–	–	–	–	–	–	–	–	2.8	2.8			
Maxstar 280 (907552) (907538) with CPS Maxstar 280 DX (907553) (907539) with CPS (907539002), CE	TIG	3-phase	1-280	IP23	250 A at 20 V	–	21	19	–	11	9	–	7	7.6	7.3	60 VDC (11 VDC**)	H: 346 mm (13.6 in.) W: 219 mm (8.6 in.) D: 569 mm (22.5 in.)	21.3 kg (47 lb.) 22.7 kg (50 lb.) with CPS
		1-phase	1-280		250 A at 20 V	–	35	32	–	18	16	–	13	7.3	7.1			
	Stick	3-phase	5-280	250 A at 30 V	–	*	*	–	14	13	–	10	9.9	9.6				
		1-phase	5-280	180 A at 27.2 V	–	32	29	–	*	*	–	*	6.7	6.5				

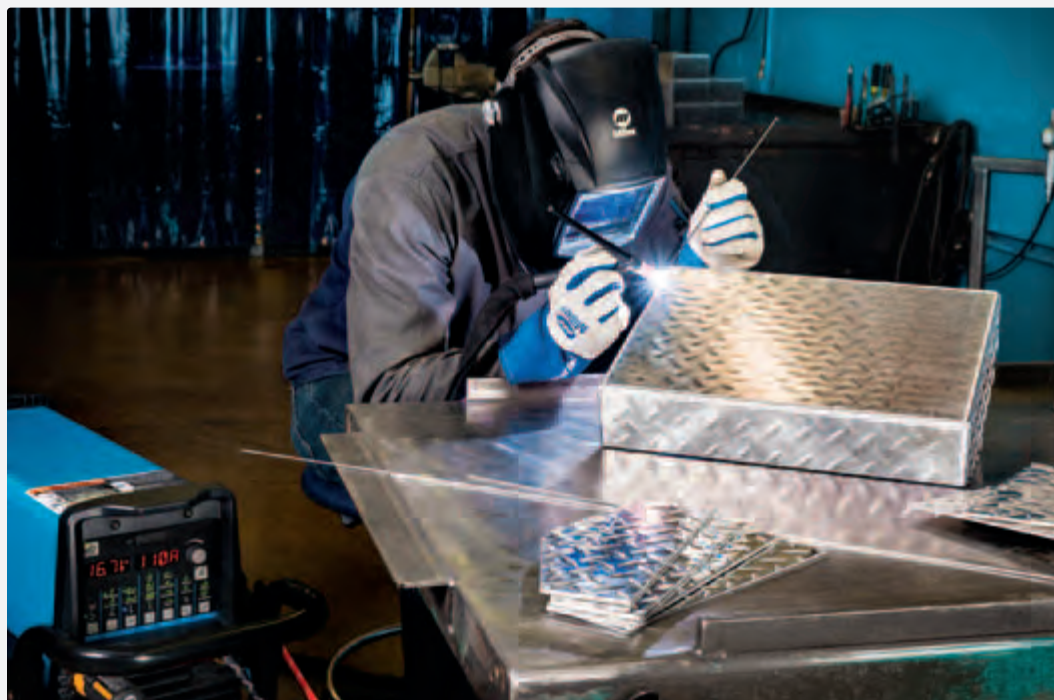

Dynasty welders add AC TIG capabilities and the following AC features (limited on base model)

Waveforms for advanced squarewave, soft squarewave, sine wave and triangular wave.

Balance control provides adjustable oxide removal which is essential for creating the highest quality aluminum welds. DX models provide extended ranges.

Frequency controls the width of the arc cone and can improve directional control of the arc.



Dynasty Water-Cooled TIGRunner (power source, Coolmate™ 1.3, Small Runner™ cart) shown.

*Refer to owner's manual for complete ratings.
**Sense voltage for low OCV stick and Lift-Arc™ TIG.

Industrial **CC** AC **3** DC **1** Phase Phase Maxstar is DC only

Processes

- TIG (GTAW) ▪ Stick (SMAW)
- Pulsed TIG (GTAW-P)
- Air carbon arc (CAC-A) w/280 models

Comes with

- 2.4 m (8 ft.) power cord (no plug)
- Quick-reference guide (Dynasty only)

Most popular accessories

- 2-Wheel Trolley Cart 300971
- Small Runner™ Cart 301318
- Coolmate™ 1.3 300972
- Coolant 043810

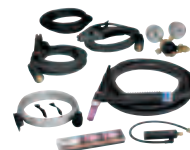

Contractor Kits

- 301309 A-150 w/RFCs-14 HD
- 301311 A-150 w/RCCS-14
- 301549 A-200 w/RFCs-14 HD
- 301550 A-200 w/RCCS-14



Weldcraft™ Water-Cooled Torch Kits

- 300185 W-250 (WP-20)
- 300990 W-280 (WP-280)
- 301268 W-375
- Remote Controls
 - 043688 RCCS-14 fingertip control
 - 194744 RFCs-14 HD foot control
 - 300429 Wireless foot control
- Dinse-style connector, Male 50 mm 134460

AC/DC Dynasty

Model/Stock Number	Welding Process	Input Power	Welding Amp Range	Rated Output at 60% Duty Cycle	Amps Input at Rated Load Output, 50/60 Hz										Max. Open-Circuit Voltage	Dimensions	Net Weight
					120 V	208 V	230 V	240 V	400 V	460 V	480 V	575 V	KVA	KW			
Dynasty 210 DX (907686) (907686002) with CPS (907686003), CE	TIG	3-phase	1-210	210 A at 18.4 V	-	14	-	12	7	-	6	-	5.2	4.9	80 VDC (11 VDC**)	H: 346 mm (13.6 in.) W: 219 mm (8.6 in.) D: 569 mm (22.5 in.)	21.3 kg (47 lb.) 22.7 kg (50 lb.) with CPS
		1-phase	1-210	210 A at 18.4 V	-	24	-	20	12	-	10	-	4.9	4.9			
		1-phase (120 V)	1-150	125 A at 15 V	22	-	-	-	-	-	-	-	-	2.6			
	Stick	3-phase	5-210	160 A at 26.4 V	-	15	-	13	8	-	6	-	5.5	5.2			
		1-phase	5-210	160 A at 26.4 V	-	26	-	22	13	-	11	-	5.3	5.3			
		1-phase (120 V)	5-100	90 A at 23.6 V	23	-	-	-	-	-	-	-	2.8	2.8			
Dynasty 280 (907550) (907537) with CPS Dynasty 280 DX (907551) (907514) with CPS (907514002), CE	TIG	3-phase	2-280 (AC) 1-280 (DC)	250 A at 20 V	-	21	19	-	11	9	-	7	7.6	7.3	60 VDC (11 VDC**)	H: 346 mm (13.6 in.) W: 219 mm (8.6 in.) D: 569 mm (22.5 in.)	23.6 kg (52 lb.) 25 kg (55 lb.) with CPS
		1-phase	2-280 (AC) 1-280 (DC)	250 A at 20 V	-	35	32	-	18	16	-	13	7.3	7.1			
	Stick	3-phase	5-280	250 A at 30 V	-	*	*	-	14	13	-	10	9.9	9.6			
		1-phase	5-280	180 A at 27.2 V	-	32	29	-	*	*	-	*	6.7	6.5			

Maxstar® and Dynasty® 400 and 800 DC (Maxstar) and AC/DC (Dynasty) TIG and Stick

See literature DC/24.5 (Maxstar) and AD/5.5 (Dynasty)



TIG Welding Capability

800 Max. 25.4 mm (1 in.)	800 Max. 25.4 mm (1 in.)
400 Max. 15.9 mm (5/8 in.)	400 Max. 15.9 mm (5/8 in.)
Steel	Aluminum (Dynasty only)
400 Min. 0.3 mm (0.012 in.)	400 Min. 0.4 mm (0.015 in.)
800 Min. 0.5 mm (0.020 in.)	800 Min. 0.5 mm (0.020 in.)

AUTO-LINE TECHNOLOGY Allows for any input voltage hook-up (208–575 V) with no manual linking, providing convenience in any job setting. Ideal solution for dirty or unreliable power.

Meter calibration allows digital meters to be calibrated for certification.

Cooler Power Supply (CPS) is an integrated 120-volt dedicated-use receptacle for the Coolmate™ 3.5.

Wind Tunnel Technology™ protects internal electrical components from airborne contaminants, extending the product life.

Fan-On-Demand™ power source cooling system operates only when needed, reducing noise, energy use and the amount of contaminants pulled through the machine.

Lift-Arc™ provides AC or DC arc initiation without the use of high frequency.

Blue Lightning™ high-frequency (HF) arc starter for non-contact arc initiation. Provides more consistent arc starts and greater reliability compared to traditional HF arc starters.

Program memory features nine independent program memories that maintain/save your parameters.

Auto-postflow adjusts the length of postflow time based on the amperage setting, shielding your tungsten and eliminating the need to set the postflow time.

AC TIG Features

Independent amplitude/amperage control allows EP and EN amperages to be set independently to precisely control heat input to the work and electrode.

Balance control provides adjustable oxide removal which is essential for creating the highest quality aluminum welds. These models provide extended ranges.

Frequency control controls the width of the arc cone and can improve directional control of the arc.

AC Waveforms

 **Advanced squarewave**, fast freezing puddle, deep penetration and fast travel speeds.

 **Soft squarewave** for a soft buttery arc with maximum puddle control and good wetting action.

 **Sine wave** for customers that like a traditional arc. Quiet with good wetting.

 **Triangular wave** reduces the heat input and is good on thin aluminum. Fast travel speeds.

DC TIG Features

Exceptionally smooth and precise arc for welding exotic materials.

Pulse. Pulsing can increase puddle agitation, arc stability and travel speeds while reducing heat input and distortion. These models provide extended ranges.

Heavy industrial ●
CC AC 3 1 Maxstar is DC only
DC Phase Phase

Processes

- TIG (GTAW) • Stick (SMAW)
- Pulsed TIG (GTAW-P)
- Air carbon arc (CAC-A)

400 models come with

- 2.4 m (8 ft.) power cord (no plug)
- Setup video and reference guide

Note: Power cord is NOT included with 800 models.

Most popular accessories

- Runner™ Cart 300244
- Coolmate™ 3.5 300245
- Coolant 043810
- Remote Controls
043688 RCCS-14 fingertip control
194744 RFCS-14 HD foot control
300429 Wireless Foot Control
- Dinse-style connector, Male 50 mm 134460



AC/DC Stick Features

DIG control allows the arc characteristics to be changed for specific applications and electrodes. Lower the DIG setting for smooth running electrodes like E7018 and increase the DIG setting for stiffer, more penetrating electrodes like E6010.

Hot Start™ adaptive control provides positive arc starts without sticking.

AC frequency control adds additional stability when stick welding in AC for smoother welds.

*Sense voltage for low OCV stick and Lift-Arc™ TIG.

	Model/Stock Number	Welding Process	Input Power	Welding Amp Range	Rated Output	Amps Input at Rated Load Output, 50/60 Hz	Max. Open-Circuit Voltage	Dimensions	Net Weight
DC Maxstar	Maxstar 400 (907716), CSA (907716002), CE (907716001) TIGRunner, CSA	TIG/stick	3-phase	3-400	300 A at 32 V, 60% duty cycle	33 30 17 15 12 12.0 11.5	75 VDC (10-15 VDC*)	H: 629 mm (24.75 in.) W: 349 mm (13.75 in.) D: 559 mm (22 in.)	61 kg (135 lb.)
				3-400	225 A at 29 V, 60% duty cycle	41 37 - 19 15 8.6 8.2			
	Maxstar 800 (907718), CSA (907718002), CE	TIG/stick	3-phase	5-800	600 A at 44 V, 60% duty cycle	89 80 46 40 32 32 31	75 VDC (10-15 VDC*)	H: 876 mm (34.5 in.) W: 349 mm (13.75 in.) D: 559 mm (22 in.)	90 kg (198 lb.)
AC/DC Dynasty	Dynasty 400 (907717), CSA (907717002), CE (907717001) TIGRunner, CSA	TIG/stick	3-phase	3-400	300 A at 32 V, 60% duty cycle	35 32 16 16 13 12.7 12.1	60 VDC (11 VDC*)	H: 629 mm (24.75 in.) W: 349 mm (13.75 in.) D: 559 mm (22 in.)	61 kg (135 lb.)
				3-400	225 A at 29 V, 60% duty cycle	47 43 - 21 17 9.8 9.1			
	Dynasty 800 (907719), CSA (907719002), CE (907719001) TIGRunner, CSA	TIG/stick	3-phase	5-800	600 A at 44 V, 60% duty cycle	97 88 51 44 35 35 34	75 VDC (10-15 VDC*)	H: 34.5 in. (876 mm) W: 349 mm (13.75 in.) D: 559 mm (22 in.)	90 kg (198 lb.)

Weldcraft™ Series TIG Torches

Synonymous with versatility and performance, Weldcraft TIG torches can handle the most intricate to the most demanding TIG welding challenges. From 125-amp hand-held MicroTIG® torches to 900-amp machine-held water-cooled models, there's a Weldcraft torch for nearly every TIG application.



For more detailed information, visit

MillerWelds.com/tigtorches



Setting the standard for performance

Super Cool™ technology provides additional surface area to increase cooling efficiency and capacity.

Comfort and control are increased with the lightweight, well-balanced body and handle designs, helping to reduce fatigue.

Robust performance through heavy copper construction that delivers maximum welding capacity for rugged fieldwork.

Simplify torch package installation with ColorSmart™ hose and cable sets that differentiate input water, water/power cable, and gas hoses.

Improve gas coverage and cooling capacity through the use of a gas lens.

Extreme reliability

Reduce downtime due to overheating through consistent water-cooled performance.

Extend parts life using the durable copper components, maximizing current capacity.

Reduce leakage of gas and water through secure mechanical fittings.

Works in cold weather with the Tri-flex™ hose and cable assembly that remains flexible to ease handling and extends cable life.

TIG Torch Configurator

Our TIG Torch Configurator is a simple way to make sure you are using the right torch and consumables for your application.

Answer a few simple questions about your specific application and get a recommendation for the appropriate torch, tungsten, collet, collet body and more. Email or print the recommendation for reference when purchasing your next Weldcraft torch.



Visit now at MillerWelds.com/torchconfig

Weldcraft™ Air-Cooled Torches

Recommended for welding amperages under 250 amps. Air-cooled torches are great for portable applications as they do not require a water-circulator. For power sources without a built-in gas solenoid, the air-cooled two-piece torch is the solution of choice.

Weldcraft™ Water-Cooled Torches

Recommended for welding amperages above 200 amps. Offering a small torch design, water-cooled torches allow for precise control due to the efficient around-the-head cooling. This same cooling allows for extended torch life and higher amperage capacities.

Weldcraft™ Specialty Torches

Specialty torches are designed to fit best in unique applications. If high amperage is your need, the **W-500** torch is the answer. The **Modular Series** torches allow for a quick change to many different torch styles for any joint configuration. For those hard-to-reach areas, the **Micro Series** torches provide access and superior maneuverability.

Weldcraft™ Automation Torches

Ideal for mechanized applications, the Weldcraft Automation Series offers air-cooled and water-cooled torches designed for high- and low-amperage mechanized applications.

Process

- TIG (GTAW)

Suggested power sources

- Multimatic™ 200/215 (A-150)
- Multimatic™ 220 AC/DC (A-150)
- Multimatic™ 255 (A-150)
- Dynasty® 280 DX Multiprocess (A-200, A-250, W-280)
- XMT Series (A-200, A-250)
- CST™ 280 (A-250)
- Maxstar® 161 STL/STH (A-150)
- Syncrowave® 210 (A-150)
- Dynasty®/Maxstar® 210 (A-150, W-250)
- Dynasty®/Maxstar® 280 (A-200, A-250, W-280)
- Dynasty®/Maxstar® 400 (W-375)
- Dynasty®/Maxstar® 800 (W-400)
- Syncrowave® 250 DX (W-375)
- Syncrowave® 350 LX (W-375)

Weldcraft™ A-80 Series

Formerly known as WP-24 Series

See literature AY/21.0



Innovative air-cooled torches designed for intricate welding applications, especially in limited-access areas and on thin-gauge materials.

Featherweight torch body is well balanced to improve operator comfort and control.

Minimize discontinuities. Insulating gasket on torch body minimizes gas leakage and minimizes weld discontinuities.

Combined flexible neck and gas valve is ideal for optimal positioning and gas flow control (A-80 Flex Valve).

Applications

- Shipbuilding • Motorsports
- Aerospace • Restricted areas

Most popular consumables

- Collets
 - 53N16 1.0 mm (.040 in.)
 - 53N14 1.6 mm (1/16 in.)
 - 24C332 2.4 mm (3/32 in.)
- Collet Bodies
 - 53N18 1.0 mm (.040 in.)
 - 53N19 1.6 mm (1/16 in.)
 - 24CB332 2.4 mm (3/32 in.)
- Alumina Nozzles
 - A53N24 #4, 6.4 mm (1/4 in.)
 - A53N25 #5, 7.9 mm (5/16 in.)
 - A53N27 #6, 9.5 mm (3/8 in.)

Most popular accessories

- Collet Body Wrench 53N20

Model	Rubber 3.8 m (12.5 ft.)	7.6 m (25 ft.)	Type	Rated Output	Electrode Range
A-80 Flex	WP-24F-12-R	WP-24F-25-R	Air-cooled	DC: 80 A at 60% duty cycle AC: 50 A at 60% duty cycle	0.5-2.4 mm (.020-3/32 in.)
A-80 Flex Valve	WP-24FV-12-R	WP-24FV-25-R			

Weldcraft™ A-125 Series

Formerly known as WP-9 Series

See literature AY/22.0



Air-cooled torches designed for optimal control while welding thin-gauge materials, especially in hard-to-reach places.

Lightweight body reduces fatigue and downtime, while increasing operator comfort.

Pencil-style model without a back cap allows for superior access to confined areas (A-125 Pencil).

Combined flexible neck and gas valve for welding limited-access joints using power sources without gas solenoids (A-125 Flex Valve).

Applications

- Maintenance and repair
- Home/hobby ▪ Motorsports
- Metal art ▪ Fabrication

Most popular consumables

- Collets
 - 13N22 1.6 mm (1/16 in.)
 - 13N23 2.4 mm (3/32 in.)
 - 13N24 3.2 mm (1/8 in.)
- Collet Bodies
 - 13N27 1.6 mm (1/16 in.)
 - 13N28 2.4 mm (3/32 in.)
 - 13N29 3.2 mm (1/8 in.)
- Alumina Nozzles
 - 13N10 #6, 9.5 mm (3/8 in.)
 - 13N11 #7, 11.1 mm (7/16 in.)
 - 13N12 #8, 12.7 mm (1/2 in.)

Most popular accessories

- Accessory Kit AK1C

Model	Rubber 3.8 m (12.5 ft.)		2-Piece Rubber 3.8 m (12.5 ft.)		Type	Rated Output	Electrode Range
	7.6 m (25 ft.)	7.6 m (25 ft.)	7.6 m (25 ft.)	7.6 m (25 ft.)			
A-125	WP-9-12-R	WP-9-25-R	WP-9-12-2	WP-9-25-2	Air-cooled	DC: 125 A at 60% duty cycle AC: 100 A at 60% duty cycle	0.5-3.2 mm (.020-1/8 in.)
A-125 Valve	WP-9V-12-R	WP-9V-25-R	WP-9V-12-2	WP-9V-25-2			
A-125 Flex	WP-9F-12-R	WP-9F-25-R	WP-9F-12-2	WP-9F-25-2			
A-125 Flex Valve	WP-9FV-12-R	WP-9FV-25-R	WP-9FV-12-2	WP-9FV-25-2			
A-125 Pencil	WP-9P-12-R	WP-9P-25-R	—	—			

Weldcraft™ A-150 Series

Formerly known as WP-17 Series

See literature AY/23.0

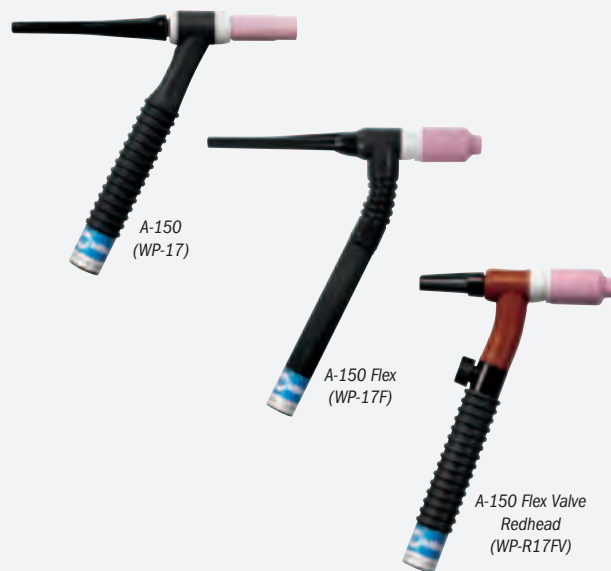

Versatile and innovative air-cooled torches designed for maximum comfort in a variety of applications.

Diamond Grip™ head design has ergonomic contact points for thumb and fingers. Provides a more comfortable grip and reduces operator fatigue (A-150 and A-150 Valve).

Improve control and comfort with a flexible neck that allows access into hard-to-reach areas (A-150 Flex).

Maximum versatility. Utilize the Redhead™ Series torches in a variety of welding applications without adding expenses.

Applications

- Fabrication ▪ Maintenance and repair
- Aerospace ▪ Food/beverage industry
- Metal art ▪ Petro/chemical
- Shipbuilding

Most popular consumables

- Collets
 - 10N23 1.6 mm (1/16 in.)
 - 10N24 2.4 mm (3/32 in.)
 - 10N25 3.2 mm (1/8 in.)
- Collet Bodies
 - 10N31 1.6 mm (1/16 in.)
 - 10N32 2.4 mm (3/32 in.)
 - 10N28 3.2 mm (1/8 in.)
- Alumina Nozzles
 - 10N48 #6, 9.5 mm (3/8 in.)
 - 10N47 #7, 11.1 mm (7/16 in.)
 - 10N46 #8, 12.7 mm (1/2 in.)

Most popular accessories

- Accessory Kit AK-150MFC
Converts A-150 into 28 different torch styles while using existing cable. Includes collets, collet bodies, nozzles, torch heads, handle and more.

Model	Rubber 3.8 m (12.5 ft.)		Mono-Flex™ 3.8 m (12.5 ft.)		2-Piece Rubber 3.8 m (12.5 ft.)		Type	Rated Output	Electrode Range
	7.6 m (25 ft.)	7.6 m (25 ft.)	7.6 m (25 ft.)	7.6 m (25 ft.)	7.6 m (25 ft.)	7.6 m (25 ft.)			
A-150	WP-17-12-R	WP-17-25-R	WP-17-12-MF	WP-17-25-MF	WP-17-12-2	WP-17-25-2	Air-cooled	DC: 150 A at 60% duty cycle AC: 115 A at 60% duty cycle	0.5-3.2 mm (.020-1/8 in.)
A-150 Valve	WP-17V-12-R	WP-17V-25-R	WP-17V-12-MF	WP-17V-25-MF	WP-17V-12-2	WP-17V-25-2			
A-150 Flex	WP-17F-12-R	WP-17F-25-R	—	—	—	WP-17F-25-2			
A-150 Flex Valve	WP-17FV-12-R	WP-17FV-25-R	—	—	WP-17FV-12-2	WP-17FV-25-2			
A-150 Flex Valve Redhead	WP-R17FV-12-R	WP-R17FV-25-R	—	—	—	—			

Weldcraft™ A-200 Series

Formerly known as WP-26 Series

See literature AY/24.0



Dependable, top-performing air-cooled torches designed for heavy-duty welding applications.

Eliminate the expense of a water-cooled system. The air-cooled capability of the A-200 Series pairs reliability with cost-effectiveness for all field applications.

Combined flexible neck and gas valve advances capabilities with greater comfort and control (A-200 Flex Valve).

Maximum versatility. Utilize the Redhead Series torches in a variety of welding applications without adding expenses.

Applications

- Fabrication ▪ Maintenance and repair
- Manufacturing ▪ Shipbuilding
- Vocational

Most popular consumables

- Collets
 - 10N23 1.6 mm (1/16 in.)
 - 10N24 2.4 mm (3/32 in.)
 - 10N25 3.2 mm (1/8 in.)
- Collet Bodies
 - 10N31 1.6 mm (1/16 in.)
 - 10N32 2.4 mm (3/32 in.)
 - 10N28 3.2 mm (1/8 in.)
- Alumina Nozzles
 - 10N47 #7, 11.1 mm (7/16 in.)
 - 10N46 #8, 12.7 mm (1/2 in.)
 - 10N45 #10, 15.9 mm (5/8 in.)

Most popular accessories



- **Gas Lens Kit AK3GL**
Includes one short back cap, one of each size (#6, #7, #8) alumina nozzle, and one of each size (1/16, 3/32, 1/8 inch) of the following: gas lens, collet, and 7-inch 2% ceriated tungsten electrode.



- **Accessory Kit AK3C**
Includes one short back cap, one of each size (#5, #6, #8) alumina nozzle, and one of each size (1/16, 3/32, 1/8 inch) of the following: collet, collet body, and 7-inch 2% ceriated tungsten electrode.

Model	Rubber 3.8 m (12.5 ft.)		2-Piece Rubber 3.8 m (12.5 ft.)		Type	Rated Output	Electrode Range
	7.6 m (25 ft.)	7.6 m (25 ft.)	3.8 m (12.5 ft.)	7.6 m (25 ft.)			
A-200	WP-26-12-R	WP-26-25-R	WP-26-12-2	WP-26-25-2	Air-cooled	DC: 200 A at 60% duty cycle AC: 150 A at 60% duty cycle	0.5-4.0 mm (.020-5/32 in.)
A-200 Valve	WP-26V-12-R	WP-26V-25-R	WP-26V-12-2	WP-26V-25-2			
A-200 Flex	WP-26F-12-R	WP-26F-25-R	WP-26F-12-2	WP-26F-25-2			
A-200 Flex Valve	WP-26FV-12-R	WP-26FV-25-R	WP-26FV-12-2	WP-26FV-25-2			
A-200 Flex Redhead	WP-R26F-12-R	—	—	—			
A-200 Flex Valve Redhead	—	WP-R26FV-25-R	—	—			

Weldcraft™ A-250 Series

See literature AY/24.5



Dependable, top-performing air-cooled torches designed for heavy-duty welding applications.

Eliminate the expense of a water-cooled system. The air-cooled capability of the A-250 Series pairs reliability with cost-effectiveness for all field applications.

Robust performance. The heavy copper construction delivers optimal welding capacity for rugged fieldwork.

Effortless adjustments. Gas control valve ensures quick and easy adjustment of shielding gas flow (A-250 Valve).

Model	2-Piece Rubber, 7.6 m (25 ft.)	Type	Rated Output	Electrode Range
A-250	301525025	Air-cooled	DC: 250 A at 60% duty cycle	0.5-4.0 mm (.020-5/32 in.)
A-250 Valve	301526025		AC: 188 A at 60% duty cycle	

Share Your Passion

Reviews & Ratings offer valuable insights to help guide your next purchase. They're written and submitted by people who have purchased and used Miller equipment. If you'd like to share your experience and help your fellow welders select the right welding equipment consider writing a review. Simply visit the product page on the website for the product you want to write about and click on "Write a Review".

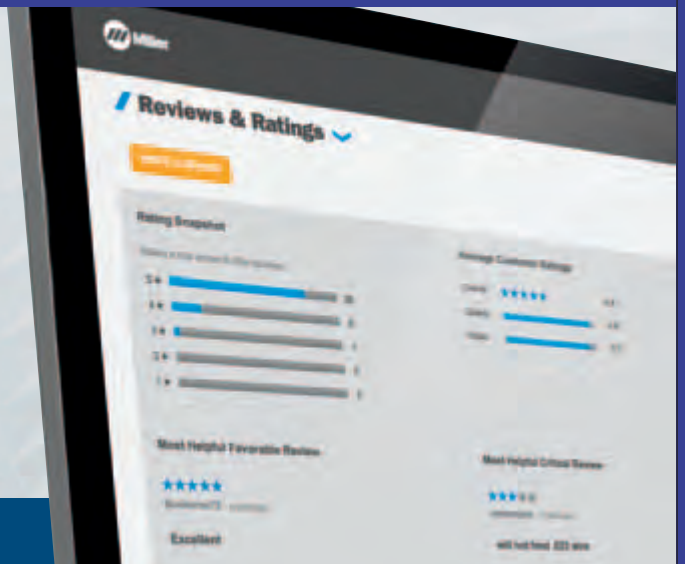

Visit now at MillerWelds.com

Weldcraft™ W-180

Formerly known as WP-24W

See literature AY/26.0



One of the smallest water-cooled TIG torches on the market and designed for welding in confined areas that require high amperage.

Use high amperage in confined areas for efficient welding.

Superior maneuverability in limited-access locations with the compact torch body.

Excellent weld capacity without increasing torch size, due to the efficient cooling system.

Applications

- Aerospace ▪ Manufacturing
- Food/beverage industry ▪ Shipbuilding
- Maintenance and repair
- Petro/chemical ▪ Precision fabrication

Most popular consumables

- Collets
 - 53N16 1.0 mm (.040 in.)
 - 53N14 1.6 mm (1/16 in.)
 - 24C332 2.4 mm (3/32 in.)
- Collet Bodies
 - 53N18 1.0 mm (.040 in.)
 - 53N19 1.6 mm (1/16 in.)
 - 24CB332 2.4 mm (3/32 in.)
- Alumina Nozzles
 - A53N24 #4, 6.4 mm (1/4 in.)
 - A53N25 #5, 7.9 mm (5/16 in.)
 - A53N27 #6, 9.5 mm (3/8 in.)

Model	Braided Rubber 3.8 m (12.5 ft.)		Vinyl 3.8 m (12.5 ft.)		Type	Rated Output	Electrode Range
W-180	WP-24W-12-R	WP-24W-25-R	WP-24W-12	WP-24W-25	Water-cooled	DC: 180 A at 100% duty cycle, AC: 115 A at 100% duty cycle	0.5-2.4 mm (.020-3/32 in.)

Weldcraft™ W-200 Pencil Flex

Formerly known as WP-25

See literature AY/27.0



Versatile water-cooled torch optimized for use in limited-access welding situations.

Pencil-style, flexible neck designed for both high-amperage applications and confined-area access.

Decreased downtime and longer trouble-free service due to overheating with the innovative cooling design.

Comfort and control are increased with the lightweight, well-balanced body design.

Applications

- Aerospace ▪ Aluminum fabrication
- Automotive ▪ Manufacturing
- Exotic material fabrication
- Precision metal fabrication
- Pressure vessel fabrication
- Shipbuilding ▪ Tool and die

Most popular consumables

- Insulator (non-gas lens and gas lens) (required) 598882
- Collets (non-gas lens and gas lens)
 - 13N21 1.0 mm (.040 in.)
 - 13N22 1.6 mm (1/16 in.)
 - 13N23 2.4 mm (3/32 in.)
 - 13N24 3.2 mm (1/8 in.)
- Collet Bodies
 - 13N26 1.0 mm (.040 in.)
 - 13N27 1.6 mm (1/16 in.)
 - 13N28 2.4 mm (3/32 in.)
 - 13N29 3.2 mm (1/8 in.)
- Gas Lens
 - 45V42 1.0 mm (.040 in.)
 - 45V43 1.6 mm (1/16 in.)
 - 45V44 2.4 mm (3/32 in.)
 - 45V45 3.2 mm (1/8 in.)

Model	Braided Rubber 3.8 m (12.5 ft.)		Vinyl 3.8 m (12.5 ft.)		Type	Rated Output	Electrode Range
W-200 Pencil Flex	WP-25-12-R	WP-25-25-R	WP-25-12	WP-25-25	Water-cooled	DC: 200 A at 100% duty cycle AC: 140 A at 100% duty cycle	0.5-3.2 mm (.020-1/8 in.)

Weldcraft™ W-250 Series

Formerly known as WP-20 Series

See literature AY/29.0



Water-cooled torches that provide consistent performance and long-term trouble-free service with around-the-head water cooling.

Extend torch life and minimize downtime due to overheating with the efficient around-the-head cooling design.

Reduce leakage of gas and water through secure mechanical fittings and connections.

Easy hose replacement with the innovative mechanical fittings design (W-250 Valve).

- Alumina Nozzles
 - 13N08 #4, 6.4 mm (1/4 in.)
 - 13N09 #5, 7.9 mm (5/16 in.)
 - 13N10 #6, 9.5 mm (3/8 in.)
 - 13N11 #7, 11.1 mm (7/16 in.)
 - 13N12 #8, 12.7 mm (1/2 in.)
 - 13N13 #10, 15.9 mm (5/8 in.)
 - 53N58 #4, 6.4 mm (1/4 in.) (gas lens)
 - 53N59 #5, 7.9 mm (5/16 in.) (gas lens)
 - 53N60 #6, 9.5 mm (3/8 in.) (gas lens)
 - 53N61 #7, 11.1 mm (7/16 in.) (gas lens)
 - 53N61S #8, 12.7 mm (1/2 in.) (gas lens)

Most popular accessories

- Cable Covers
 - WC-3-10 3 m (10 ft.)
 - WC-3-22 6.7 m (22 ft.)

Model	Braided Rubber 3.8 m (12.5 ft.)		Vinyl 3.8 m (12.5 ft.)		Type	Rated Output	Electrode Range
W-250	WP-20-12-R	WP-20-25-R	WP-20-12	WP-20-25	Water-cooled	DC: 250 A at 100% duty cycle AC: 180 A at 100% duty cycle	0.5-3.2 mm (.020-1/8 in.)
W-250 Valve	—	—	—	WP-20V-25			

Weldcraft™ W-280 Super Cool™

Formerly known as WP-280

See literature AY/30.0



Reliable water-cooled torch designed for demanding, high-amperage applications.

Super Cool technology provides additional surface area to increase cooling efficiency and capacity.

Reduce downtime due to overheating through consistent water-cooled performance.

Reduce leakage of gas and water through secure mechanical fittings and connections.

Model	Braided Rubber		Braided Rubber with 50 mm Dinse 7.6 m (25 ft.)	Type	Rated Output	Electrode Range
	3.8 m (12.5 ft.)	7.6 m (25 ft.)				
W-280 Super Cool	301251012	301251025	301251001	Water-cooled	DC: 280 A at 100% duty cycle AC: 195 A at 100% duty cycle	0.5-3.2 mm (.020-1/8 in.)

Applications

- Aerospace ▪ Aluminum fabrication
- Automotive ▪ Manufacturing
- Exotic material fabrication
- Precision metal fabrication
- Pressure vessel fabrication
- Shipbuilding ▪ Tool and die
- Tube and pipe ▪ Vocational

Most popular consumables

- Insulator (non-gas lens and gas lens) (required) 598882
- Collets (non-gas lens and gas lens)
 - 13N21 1.0 mm (.040 in.)
 - 13N22 1.6 mm (1/16 in.)
 - 13N23 2.4 mm (3/32 in.)
 - 13N24 3.2 mm (1/8 in.)
- Collet Bodies
 - 13N26 1.0 mm (.040 in.)
 - 13N27 1.6 mm (1/16 in.)
 - 13N28 2.4 mm (3/32 in.)
 - 13N29 3.2 mm (1/8 in.)
- Gas Lens
 - 45V42 1.0 mm (.040 in.)
 - 45V43 1.6 mm (1/16 in.)
 - 45V44 2.4 mm (3/32 in.)
 - 45V45 3.2 mm (1/8 in.)

Weldcraft™ W-375 Super Cool™

See literature AY/32.5



Reliable water-cooled torch designed for demanding, high-amperage applications.

Super Cool technology provides additional surface area to increase cooling efficiency and capacity.

Reduce downtime due to overheating through consistent water-cooled performance.

Reduce leakage of gas and water through secure mechanical fittings and connections.

Model	Braided Rubber		Braided Rubber with 50 mm Dinse 7.6 m (25 ft.)	Type	Rated Output	Electrode Range
	3.8 m (12.5 ft.)	7.6 m (25 ft.)				
W-375 Super Cool	301253012	301253025	301253001	Water-cooled	DC: 375 A at 100% duty cycle AC: 265 A at 100% duty cycle	0.5-3.2 mm (.020-1/8 in.)

Alumina Nozzles

- 13N08 #4, 6.4 mm (1/4 in.)
- 13N09 #5, 7.9 mm (5/16 in.)
- 13N10 #6, 9.5 mm (3/8 in.)
- 13N11 #7, 11.1 mm (7/16 in.)
- 13N12 #8, 12.7 mm (1/2 in.)
- 13N13 #10, 15.9 mm (5/8 in.)
- 53N58 #4, 6.4 mm (1/4 in.) (gas lens)
- 53N59 #5, 7.9 mm (5/16 in.) (gas lens)
- 53N60 #6, 9.5 mm (3/8 in.) (gas lens)
- 53N61 #7, 11.1 mm (7/16 in.) (gas lens)
- 53N61S #8, 12.7 mm (1/2 in.) (gas lens)

Back Caps

- 41V33 Short
- 41V35 Medium
- 41V24 Long

Weldcraft™ W-350 Series

Formerly known as WP-18 Series

See literature AY/32.0



W-350 (WP-18)

W-350 Valve (WP-18V)

Rugged water-cooled torches engineered for high-amperage and continuous hand-held welding in mechanized applications.

Reduce downtime and costs by minimizing overheating with the unique cooling design engineered for operator comfort.

Reduce discomfort and fatigue using the comfortable handle design.

Superior gas flow control offered through the built-in fingertip gas control (W-350 Valve).

Model	Rubber		Vinyl		Type	Rated Output	Electrode Range
	3.8 m (12.5 ft.)	7.6 m (25 ft.)	3.8 m (12.5 ft.)	7.6 m (25 ft.)			
W-350	WP-18-12-R	WP-18-25-R	WP-18-12	WP-18-25	Water-cooled	DC: 350 A at 100% duty cycle AC: 250 A at 100% duty cycle	0.5-4.0 mm (.020-5/32 in.)
W-350 Valve	—	WP-18V-25-R	—	WP-18V-25			

Applications

- Fabrication ▪ Manufacturing
- Maintenance and repair
- Shipbuilding ▪ Tube and pipe

Most popular consumables

- Collets
 - 10N24 2.4 mm (3/32 in.)
 - 10N25 3.2 mm (1/8 in.)
 - 54N20 4.0 mm (5/32 in.)
- Collet Bodies
 - 10N32 2.4 mm (3/32 in.)
 - 10N28 3.2 mm (1/8 in.)
 - 406488 4.0 mm (5/32 in.)
- Alumina Nozzles
 - 10N48 #6, 9.5 mm (3/8 in.)
 - 10N47 #7, 11.1 mm (7/16 in.)
 - 10N46 #8, 12.7 mm (1/2 in.)
 - 10N45 #10, 15.9 mm (5/8 in.)
 - 10N44 #12, 19 mm (3/4 in.)

Weldcraft™ W-400 Super Cool™

Formerly known as WP-18SC

See literature AY/33.0



Water-cooled torch designed to endure some of the most demanding applications while minimizing overheating.

Extend torch and consumable life with the full-flow water chamber that provides around-the-head cooling.

Improve gas coverage and cooling capacity with gas lens usage with heavy-duty stubby collet body.

Extend parts life using the durable copper components, maximizing current capacity.

Applications

- Heavy fabrication ▪ Tool and die
- Pipe and tube fabrication
- Pressure vessel fabrication

Most popular consumables

- Heavy-Duty Collets
 - 10N25HD 3.2 mm (1/8 in.)
 - 54N20HD 4.0 mm (5/32 in.)
 - 18C36 4.8 mm (3/16 in.)
- Heavy-Duty Nose Collet Body (all sizes) NCB-36
- Alumina Nozzles
 - 54N16 #6, 9.5 mm (3/8 in.)
 - 54N15 #7, 11.1 mm (7/16 in.)
 - 54N14 #8, 12.7 mm (1/2 in.)
- Back Caps
 - 57Y04 Short
 - 300M Medium

Model	Rubber, 7.6 m (25 ft.)	Vinyl, 7.6 m (25 ft.)	Type	Rated Output	Electrode Range
W-400 Super Cool	WP-18SC-25-R	WP-18SC-25	Water-cooled	DC: 400 A at 100% duty cycle, AC: 280 A at 100% duty cycle	0.5-4.8 mm (.020-3/16 in.)

Weldcraft™ Modular Series

See literature AY/36.0



Air-cooled and water-cooled torches engineered to weld multiple joint configurations for various applications and angles.

Built-in, efficient cooling system reduces overheating to extend parts and consumable life.

Modular design minimizes costs and downtime for torch changeover and parts inventory.

Easy configurable head options provide greater flexibility and joint access, minimizing downtime for torch changeover.

Gas valve provides greater shielding gas flow control (A-150 Modular Valve).

Applications

- Maintenance and repair ▪ Aerospace
- Metal art ▪ Food/beverage industry
- Petro/chemical ▪ Shipbuilding
- Manufacturing ▪ Vocational
- Precision fabrication ▪ Tube and pipe

Most popular accessories



Accessory Kit

- AK-150MFC For A-150 torch
- AK-225MFC For W-225 torch

Model	Rubber 3.8 m (12.5 ft.)	7.6 m (25 ft.)	Type	Rated Output (Torch head dependent)	Electrode Range (Torch head dependent)	
A-150 Modular	WP-150-12-R	WP-150-25-R	Air-cooled	DC: 150 A at 60% duty cycle AC: 105 A at 60% duty cycle	0.5-3.2 mm (.020-1/8 in.)	
A-150 Modular Valve	WP-150V-12-R	WP-150V-25-R				
Model	Braided Rubber 3.8 m (12.5 ft.)	7.6 m (25 ft.)	Vinyl 7.6 m (25 ft.)	Type	Rated Output (Torch head dependent)	Electrode Range (Torch head dependent)
W-225 Modular	WP-225-12-R	WP-225-25-R	WP-225-25	Water-cooled	DC: 225 A at 100% duty cycle AC: 160 A at 100% duty cycle	0.5-4.0 mm (.020-5/32 in.)

Weldcraft™ W-125 Long Micro

Formerly known as WP-125L

See literature AY/25.0



Water-cooled MicroTig® torch designed for limited-access joints.

Small 5-inch torch body designed for limited-access joints.

Low-profile nozzle fits into holes as small as 5/8-inch diameter.

45-degree, 90-degree, and 180-degree options improve access in tight areas.

Lower maintenance costs incurred with the replaceable silicone rubber insulator and head components.

Applications

- Aerospace ▪ Food/beverage industry
- HVAC ▪ Automotive ▪ Petro/chemical
- Precision fabrication

Most popular consumables

- 90° Chucks
 - 125C40-90 1.0 mm (.040 in.)
 - 125C116-90 1.6 mm (1/16 in.)
 - 125C332-90 2.4 mm (3/32 in.)
- 90° Glass Nozzle (all sizes) 125N90 (other nozzles are available)



Model	Braided Rubber 3.8 m (12.5 ft.)	7.6 m (25 ft.)	Vinyl 7.6 m (25 ft.)	Type	Rated Output	Electrode Range
W-125 Long Micro	WP-125L-12-R	WP-125L-25-R	WP-125L-25	Water-cooled	DC: 125 A at 100% duty cycle AC: 80 A at 100% duty cycle	1.0-2.4 mm (.040-3/32 in.)

Weldcraft™ Automation Series

See literature AY/37.0



Air-cooled and water-cooled torches designed for high- and low-amperage mechanized applications.

Minimize downtime associated with tungsten changeover by using the front or back tungsten loading areas.

Built-in gas lens improves gas coverage to minimize shielding gas turbulence and improve weld quality (W-500A Automation and W-500B Automation).

Handle the most demanding high-amperage applications (W-500 Automation).

Applications

- Aerospace
- Food/beverage industry
- Pressure vessel fabrication
- Petro/chemical

Most popular accessories

▪ Cable Covers

- WC-3-10 3 m (10 ft.)
- WC-3-22 6.7 m (22 ft.)
- WC-4-10 3 m (10 ft.)
- WC-4-22 6.7 m (22 ft.)



▪ Air-Cooled Torch 1-Piece Power Cable Connector

- 195378 50 mm Dinse-style



▪ Water-Cooled Torch 1-Piece Power Cable Connectors

- 195377 50 mm Dinse-style
- 225028 50 mm thread-lock

Model	Rubber, 3.8 m (12.5 ft.)		2-Piece Rubber, 3.8 m (12.5 ft.)			Type	Rated Output	Electrode Range
A-150 Automation	WP-23A-12-R		WP-23A-12-2			Air-cooled	DC: 150 A at 60% duty cycle AC: 120 A at 60% duty cycle	1.0-2.4 mm (.040-3/32 in.)
Model	Rubber 0.9 m (3 ft.)	3.8 m (12.5 ft.)	Vinyl 0.9 m (3 ft.)	3.8 m (12.5 ft.)	7.6 m (25 ft.)	Type	Rated Output	Electrode Range
W-250 Automation	—	—	WP-22A-3	WP-22A-12	WP-22A-25	Water-cooled	DC: 250 A at 100% duty cycle AC: 180 A at 100% duty cycle	1.0-3.2 mm (.040-1/8 in.)
W-500A Automation	WP-27A-3	WP-27A-12	—	—	—	Water-cooled	DC: 500 A at 100% duty cycle AC: 350 A at 100% duty cycle	1.0-6.4 mm (.040-1/4 in.)
W-500B Automation	WP-27B-3	WP-27B-12	—	—	—	Water-cooled	DC: 500 A at 100% duty cycle AC: 350 A at 100% duty cycle	1.0-6.4 mm (.040-1/4 in.)

Weldcraft™ Tungsten

Tungsten for the most demanding TIG welding applications!

Available in four types and industry-standard diameters, our line of Weldcraft tungsten electrodes has undergone rigorous testing to ensure the highest quality and durability. Color-coded packages include ten 175 mm (7 in.) tungsten electrodes.

Type	Stock Number	Diameter mm (in.)	Type	Stock Number	Diameter mm (in.)
2% Ceriated (EWCe-2)			Pure (EWP)		
Performs well in DC welding and arc starting at low-current settings, and offers excellent performance in AC processes.	WC040X7	1.0 (0.040)	Forms a clean, balled end when heated and provides good arc stability for AC welding with a balanced or unbalanced squarewave or sine wave.	—	1.0 (0.040)
	WC116X7	1.6 (1/16)		WP116X7	1.6 (1/16)
	WC332X7	2.4 (3/32)		WP332X7	2.4 (3/32)
	WC018X7	3.2 (1/8)		WP018X7	3.2 (1/8)
	WC532X7	4.0 (5/32)		—	4.0 (5/32)
2% Lanthanated (EWLa-2)			Rare Earth (EWG)		
Provides excellent arc starting, arc stability and re-ignition, and less tip erosion in AC or DC welding. Can substitute for 2% Thoriated.	WL2040X7	1.0 (0.040)	Combines the best of all alloying elements, and provides excellent arc stability in AC or DC welding.	—	1.0 (0.040)
	WL2116X7	1.6 (1/16)		WG116X7	1.6 (1/16)
	WL2332X7	2.4 (3/32)		WG332X7	2.4 (3/32)
	WL2018X7	3.2 (1/8)		WG018X7	3.2 (1/8)
	WL2532X7	4.0 (5/32)		—	4.0 (5/32)



Note: Refer to manufacturer SDS sheets for proper preparation and safety. Use proper ventilation/capture during preparation. Refer to manufacturer warning regarding ventilation.

Weldcraft™ TIG Torch Accessories

GL Kits (Gas Lens Kits)

Gas lenses improve the gas coverage of the tungsten during the TIG welding process. They can save you time and money by increasing your weld quality while using less gas. GL Kits provide three different-sized gas lenses and consumables in each kit to work with a variety of different applications.

AK3GL
For A-150, A-200 and A-250. Includes one short back cap, one of each size (#6, #7, #8) alumina nozzle, and one of each size (1/16, 3/32, 1/8 inch) of the following: gas lens, collet, and 7-inch 2% ceriated tungsten electrode.

AK4GL
For W-200, W-225, W-250, W-280 and W-375. Includes one short back cap, one of each size (#6, #7, #8) alumina nozzle, and one of each size (1/16, 3/32, 1/8 inch) of the following: gas lens, collet, and 7-inch 2% ceriated tungsten electrode.

AK Kits (Accessory Kits)

AK consumables kits provide a set of different consumables for Weldcraft torches to tackle a variety of different applications. Kits include nozzles, collets, collet bodies, tungsten and back caps.

AK1C
For A-125 Series. Includes one long back cap, one of each size (#4, #5, #6) alumina nozzle, and one of each size (.040, 1/16 inch) of the following: collet, collet body, and 7-inch 2% ceriated tungsten electrode.

AK2C
For A-150 Series. Includes one short back cap, one of each size (#4, #5, #6) alumina nozzle, and one of each size (.040, 1/16, 3/32 inch) of the following: collet, collet body, and 7-inch 2% ceriated tungsten electrode.

AK3C
For A-200 Series, A-250 Series and W-350 Series. Includes one short back cap, one of each size (#5, #6, #8) alumina nozzle, and one of each size (1/16, 3/32, 1/8 inch) of the following: collet, collet body, and 7-inch 2% ceriated tungsten electrode.

AK4C
For W-250 Series, W-280 Super Cool, W-375 Super Cool and W-410. Includes one long back cap, one of each size (#5, #6, #7) alumina nozzle, and one of each size (1/16, 3/32, 1/8 inch) of the following: collet, collet body, and 7-inch 2% ceriated tungsten electrode.

AK18C
For W-400 Super Cool. Includes one short back cap, one of each size (#6, #7, #8) alumina nozzle, one of each size (3/32, 1/8 HD, 5/32 HD) collet, one of each size (.020-1/8 inch, 1/8-3/16 inch) collet body, and one of each size (3/32, 1/8, 5/32 inch) 7-inch 2% ceriated tungsten electrode.

AK125C
For W-125 Micro Series. Includes one of each size (180°, 45°, 90°, 90° short) glass nozzle, and one of each size (.040, 1/16 inch) of the following: 180-degree chuck, 45-degree chuck, 90-degree chuck, and 7-inch 2% ceriated tungsten electrode.

AK-150MFC
For A-125 Series, A-150 Series and A-150 Modular Series. Allows welding operators to customize their standard A-150 (WP-17) or A-125 (WP-9) TIG torch for their specific application. Kit converts into 28 different torch styles while using the A-150 and A-125 existing cable. Features collets, collet bodies, nozzles, torch heads, handle and more.

AK-225MFC
For W-225 Modular. Includes five additional torch heads, collets, collet bodies, nozzles, handle and more.

MAK-2S
For W-350 Series. Includes one short and one long back cap, four back cap o-rings, two cup gaskets, one gas lens insulator, and one of each size (.040, 1/16, 3/32, 1/8 inch) gas lens. Also includes the following: ten collets (1) .040, (3) 1/16, (3) 3/32, (2) 1/8, (1) 5/32; and eight collet bodies (1) .040, (2) 1/16, (2) 3/32, (2) 1/8, (1) 5/32.

Quick Connects



QRG
Allows for quick connection and removal of torch shielding gas hoses.



QRW
Allows for quick connection and removal of torch coolant hoses.

Cable Covers



WC-3-10 3 m (10 ft.)
WC-3-22 6.7 m (22 ft.)
WC-3-48 14.6 m (48 ft.)
Cable covers protect the welding cables from the day-to-day wear and tear of common welding

environments. Available in 10-foot, 22-foot, and 48-foot lengths, these covers can help prevent the frequent replacement of expensive welding cable.

Remote Controls

See Accessories section for more information.



East/west rotary-motion fingertip current/contactor controls.



North/south rotary-motion fingertip current/contactor controls.

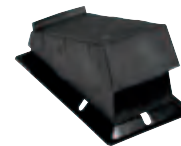

Foot pedal current/contactor controls.



Miniature hand current/contactor controls.



Momentary- and maintained-contact rocker switch for contactor control.



Momentary-contact switch for contactor controls.



Remote on/off control.



For more detailed information, visit

MillerWelds.com/insight

Welding Intelligence™



Insight Welding Intelligence™: The Total Welding Data Solution

With an Insight weld monitoring system you can get more done, produce higher-quality welds and control costs.



Complete coverage for any application.



Manufacturing



Automation



Submerged arc

Choose the Right Welding Intelligence System

		Insight Core™	Insight Centerpoint™	Insight ArcAgent™
For Use With	Factory-Installed	<ul style="list-style-type: none"> Continuum™/Auto-Continuum™ (standard) Deltaweld® (optional) 	<ul style="list-style-type: none"> Continuum™/Auto-Continuum™ (optional) 	<ul style="list-style-type: none"> ANY welding power source (old or new) ANY brand ANY welding process
	Field-Installed/Activated	<ul style="list-style-type: none"> 14-pin compliant power source (see MillerWelds.com/insight) 	<ul style="list-style-type: none"> Continuum™/Auto-Continuum™ 	
Requirements		<ul style="list-style-type: none"> Internet connection (wired/wireless) 	<ul style="list-style-type: none"> PC and Ethernet connection 	<ul style="list-style-type: none"> See Insight ArcAgent literature WI/1.0
What Capability Do You Need?		<ul style="list-style-type: none"> Productivity monitoring Weld parameter verification Goal setting Analytic tools 	<ul style="list-style-type: none"> Ensure quality welds Reduce missed welds Minimize overwelding/underwelding Electronic work instructions 	<ul style="list-style-type: none"> Universal solution for use with Insight Core or Insight Centerpoint
Data Storage		<ul style="list-style-type: none"> Cloud based 	<ul style="list-style-type: none"> Local server or PC 	<ul style="list-style-type: none"> See Insight ArcAgent literature WI/1.0



Insight Core™

Simple, cloud-based welding information management solution that reports operator productivity and deposition, as well as weld parameter verification.



Helps you answer

- Who is your most productive operator?
- What is your most productive welder, station, cell?
- Are your quality risks increasing or decreasing?
- What are your true welding costs?

Software features

Productivity dashboard. Instant visibility of arc-on time and wire deposition – by location, work cell, power source or operator.

Quality dashboard. Real-time analysis and reporting of all welds, revealing when quality fails to meet established thresholds for amps, volts and WFS. Includes weld trace.

Reports. In-depth information is available in reports that can be easily modified and displayed in a wide variety of customizable formats.

Analytics tools. Business analytic tools allowing for weld data analysis based on individual/cell performance as well as overall financial terms.

Notifications. Email/text notifications based on your desired frequency and subject.

Multiple languages available. English, German, Spanish, French, Italian, Dutch, Portuguese and Chinese.

Universal brand capability

With an ArcAgent™ module, you can have the power of Insight Core on any machine from any manufacturer, giving you complete coverage of your facility.

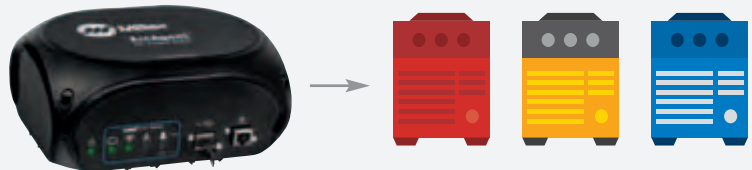

¹ Additional stock numbers are available – visit MillerWelds.com/insight.

² SubArc Digital Series requires Insight Core to SubArc Digital Series Adapter Kit (301295).

³ TIG applications require TIG Filter (301359) to monitor voltage.

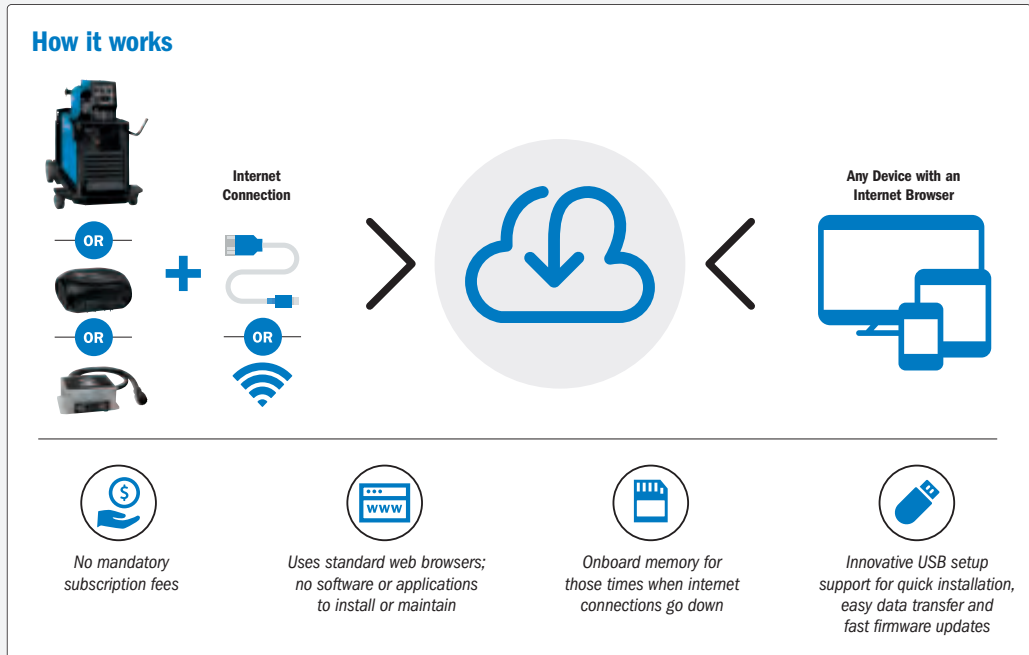

Type	Power Sources ¹	Miller 14-Pin Compliant Power Sources	Universal Adaptability (works with ALL brands/models of power sources)
Factory-Installed Insight Core	Deltaweld® 350 (907747002) 208/230/460 V Deltaweld® 500 (907785002) 208/230/460 V Continuum 350 (907636) Continuum 500 (907640) Auto-Continuum 350 (907656) Auto-Continuum 500 (907657)	–	–
Field-Installed Insight Core	–	Requires Insight Core 14-pin module ² (301072), CE See MillerWelds.com/insight for a list of 14-pin compatible power sources	ArcAgent for Insight Core ³ (301357) Dinse current sensor 600 A (301367) Dinse sensor cable 7.6 m (301516) Dinse volt sense cable 7.6 m (301496) Dinse ArcAgent, CE ArcAgent for Insight Core (301351) Stud current sensor 600 A (301364) Stud sensor cable 7.6 m (301365) Stud volt sense cable 7.6 m (301496) Stud ArcAgent, CE

Insight Centerpoint™

Advanced, real-time operator feedback solution to prevent missed welds, enforce proper weld sequences and ensure consistent weld quality.

Version 10

- Designed for ease of use
- Faster start up time
- Drastically shortened learning curve

Software features

Part Tracking™ provides real time operator feedback to ensure accurate weld sequence, prevent missed welds and ensure proper weld parameters.

WorkFlow™ enables you to present electronic work instructions for pre-weld, intra-weld, and post-weld activities (using video, pdf, and more) to ensure consistent standardized production for every operator.

Job tracking. A browser-based user interface eliminates the need for a PC in the workstation, allowing an operator to easily record everything that goes into creating a part.



Benefits for everyone in your operation



Improve weld quality

- Create a full record of every weld on every part
- Present welders with step-by-step instructions
- Have confidence that parts are properly welded



Increase productivity

- Save time inspecting welds
- Identify the impact of non-welding activities
- Keep your welders welding



Manage costs

- Identify the true cost of a welded component
- Collect data to drive decisions
- Stop losing money due to missing or poor welds

How it works

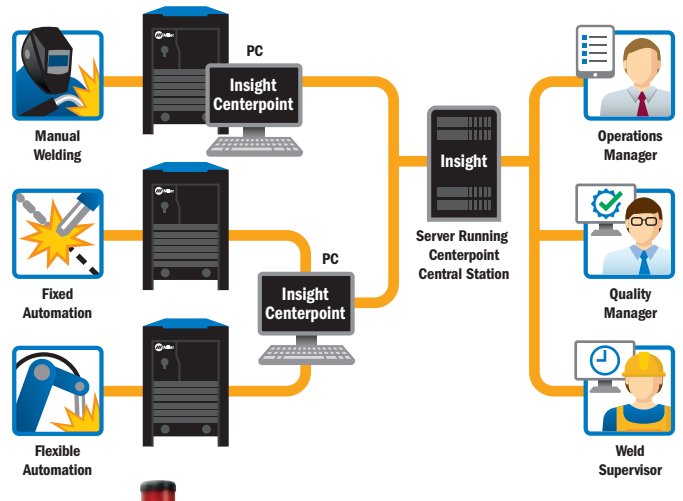

For more information:

email insight@MillerWelds.com

Universal brand capability

With an ArcAgent™ module, you can have the power of Insight Centerpoint on any machine from any manufacturer, giving you a complete picture of your facility.

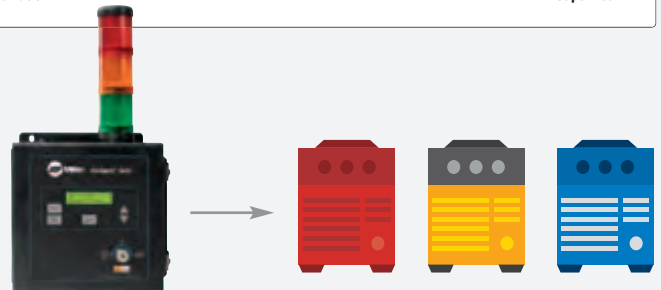

¹ Additional stock numbers are available – visit MillerWelds.com/insight.

Type	Power Sources ¹	Universal Adaptability (works with ALL brands/models of power sources)	Insight Centerpoint Software	Accessories
Optional Factory-Installed Insight Centerpoint	Deltaweld® 350 (907747002) 208/230/460 V Deltaweld® 500 (907785002) 208/230/460 V Continuum 350 (907636) Continuum 500 (907640) Auto-Continuum 350 (907656) Auto-Continuum 500 (907657)	–	(301490) Software activation (Serial number required)	Insight LTD Gun (Q4015JS3EML) For Continuum Insight LTD Remote (301383) M12/RJ45 Ethernet Cables (300734) 3 m (9.8 ft.) (300736) 10 m (32.8 ft.) Field Application Support (195480) Miller field support (contact distributor for details)
Field-Installed Insight Centerpoint	–	Requires ArcAgent Manual or Auto (301345) Manual with Insight torch capability, CE (301346) Auto, CE	(301485) Seat license	

Fusion 160

See literature ED/2.8

The Fusion 160 delivers a smooth, stable arc from either engine power or 120/240-volt utility power, providing a unique combination of versatility and productivity in a lightweight package.



POWER SHIFT

Work anywhere convenience.

PowerShift technology provides weld capabilities using either the Fusion 160 gasoline engine or 120/240-volt utility power. You'll have the confidence of knowing

that you can weld virtually anywhere – outdoors and indoors – with just one machine. The multi-voltage plug (MVP™) makes it easy to connect the welder to either 120- or 240-volt power.

Easier to transport. The Fusion 160 welder/generator weighs 110 kg (242 lb.). That's up to 20 kg (45 lb.) less than similar machines, so moving the Fusion 160 is easier and faster. Less time is spent waiting, and more work can get done.

Less rework. The Fusion 160 uses inverter technology to deliver a smooth, stable stick arc that's forgiving of variations in arc length and travel speed, so it's easier to produce clean welds that meet specifications – and avoid the time and expense of rework.

Light industrial ● **CC DC** 1 Phase

Process

- Stick (SMAW)

Gasoline engine

Kohler CH440: 13.4 hp at 3,600 rpm
One-cylinder, four-cycle, OHV, air-cooled

Note: Engine is warranted separately by engine manufacturer.

Most popular accessories

- Lifting Eye 195353
- Running Gear 301246
- Twist Lock Adapter Cord 301489
- Protective Cover 301245

Gasoline	Stock Number	Input Power	Welding Mode	Welding Process	Amperage Range	Rated Output at 40°C (104°F)	Amps Input at Rated Output, 50/60 Hz, 1-Phase	Single-Phase Generator Power at 40°C (104°F)	Dimensions	Net Weight	
	(907773) Kohler with electric start	Engine power	CC/DC	DC stick	30-160	160 A at 26.4 V, 20% duty cycle 110 A at 24.4 V, 100% duty cycle	–	–	Peak: 6,500 watts Continuous: 6,200 watts	H: 629 mm (24.75 in.) W: 510 mm (20.125 in.) D: 794 mm (31.25 in.)	110 kg (242 lb.)
		Power Shift 120 V			30-100	90 A at 23.6 V, 40% duty cycle	22.7	–			
		Power Shift 240 V			30-160	160 A at 26.4 V, 20% duty cycle 110 A at 24.4 V, 100% duty cycle	25.0	–			

Blue Star® 185

See literature ED/2.5

Reliable outdoor portable power! Great for farm, ranch, maintenance, construction and hobbyist.



Compact and portable, its small footprint uses little truck space. Optional running gear also makes the Blue Star one-man portable.

All engine controls are on front panel.

Stick and TIG capable.

Accu-Rated™ peak generator power is usable for maximum generator loads such as plasma cutting, Millermatic® MIG welders and motor starting.

Includes electric start, 120-volt GFCI and 240-volt receptacles, 23.7 L (6.25 gal.) fuel capacity, auto-idle and engine hour meter.

Light industrial ● **CC DC**

Processes

- Stick (SMAW) ▪ TIG (GTAW)

Gasoline engine

Kohler CH440: 13.4 hp at 3,600 rpm
One-cylinder, four-cycle, OHV, air-cooled

Note: Engine is warranted separately by engine manufacturer.

Most popular accessories

- Lifting Eye 195353
- Running Gear 301246
- Protective Cover 301245

Gasoline	Stock Number	Welding Mode	Welding Process	Amperage Range	Rated Output at 40°C (104°F)	Single-Phase Generator Power at 40°C (104°F)	Dimensions	Net Weight
	(907664) Kohler	CC/DC	DC stick/TIG	60-185	185 A at 25 V, 20% duty cycle 150 A at 25 V, 100% duty cycle	Peak: 6,500 watts Continuous: 6,200 watts	H: 629 mm (24.75 in.) W: 524 mm (20.625 in.) D: 794 mm (31.25 in.)	134 kg (296 lb.)

Bobcat™/Trailblazer® Gas Model Comparison – Which is Right for You?

*Based on typical usage – 150 amps welding 40% of the time; 20 amps generator power 30% of the time; and idling without load 30% of the time.

Bobcat: The most popular welder/generator

- Dependable power and weld output
- Cost-effective multiprocess welder/generator
- Easy to maintain
- Quietest in its class



Trailblazer: The best performer in the industry

- Unbeatable arc performance
- Independent welder and generator power system
- Exclusive technologies – Auto-Speed™ and Excel™ power
- Most fuel efficient and quietest in its class



	Bobcat 225	Bobcat 260	Trailblazer 325
Sound Levels (at 23 feet)			
At Maximum Load/ At 150 Amps	73.5 dB/ 72 dB	72.5 dB/ 72 dB	74 dB/65 dB
Sound Quality	Good	Very good	Excellent
Fuel System			
Typical Runtime per 12-Gallon Tank*	13 hours	13/ 15.5 hours with EFI	Up to 21 hours with options
Efficiency	Good	Good/ Very good with EFI	Excellent
Type	Gasoline	Gasoline or LP	Gasoline or LP
Delivery	Carburetor	Carburetor or EFI available	Carburetor or EFI available
Generator			
Peak Watts	11,000 watts	11,000/ 12,000 watts with EFI	12,000 watts
Clean Power Quality	Very good/ Excellent	Very good/ Excellent	Excellent
Power While Welding	Fair/Good – With voltage control set near maximum	Good – Easier to fine-tune with arc voltage control near maximum	Independent weld and generator power with no interaction between tools and welding arc
Excel™ Power Generator (120 V, 60 Hz at all engine speeds)	–	–	Excel power available (EFI models)
Weld Performance			
Stick	Good/ Very good	Very good	Excellent
MIG – Wire (solid/ FCAW), Steel	Fair (.035 in.)	Good (.035-1/16 in.)	Excellent (.023-1/16 in.)
MIG – Wire, Aluminum w/Spool Gun	Fair/Good (add WC-115A with contactor)	Very good (add WC-115A with contactor)	Excellent (add WC-24)
DC TIG (steel)	Good	Very good	Excellent
AC Weld	60-160 amps	40-260 amps	Add Dynasty®
Carbon Arc Gouging	–	Good Carbons: Rated 3/16 in.	Very good Carbons: Rated 3/16 in., Capable 1/4 in.
Key Features			
Digital Meters	–	–	With Sunvision™
Maintenance Displays	Hours/Oil change	Hours/Oil change/ Fuel	Hours/Oil change/ Fuel/ rpm
Battery Charge/ Crank Assist	–	–	12/24-volt available
14-pin Receptacle	–	–	With Auto Remote Sense™
	–	–	ArcReach technology available

Bobcat™/Trailblazer®/Big Blue® Air Pak™ Comparison – Which is Right for You?

Cost-effective welder/generator/air compressor/battery charger



AC/DC multiprocess welder/generator/air compressor/battery charger



Heavy-duty, dual-operator welder/generator/air compressor



	Bobcat 200 Air Pak	Trailblazer 302 Air Pak	Big Blue 800 Duo Air Pak
Compressed Air	28 cfm, 175 psi	31 cfm, 160 psi	60 cfm, 100 psi
Battery Charge/Crank Assist	12/24-volt	12/24-volt	–
Generator Power	Single-phase	Peak: 5,500 watts Continuous: 5,500 watts	Peak: 15,000 watts Continuous: 12,000 watts
	Three-phase	–	Peak: 27,000 watts Continuous: 20,000 watts
Weld Output Range	50-210 amps (CC/DC)	10-300 amps (CV/DC, CC/DC, CC/AC)	Single weld mode: 40-800 amps Dual weld mode: 20-400 amps (CV/DC, CC/DC)
Fuel Type	Gas	Gas	Diesel
Size	23.76 x 20 x 46.64 in.	28 x 20 x 59.625 in.	46 x 28.5 x 69.5 in.
Weight	558 lb.	771 lb.	2,095 lb.
	–	–	ArcReach technology standard

Bobcat™ 200 Air Pak™ See literature ED/4.36

Quiet, fuel-efficient all-in-one that maintains power capabilities in a compact, lightweight footprint and is backed by industry-leading reliability and performance.



Bobcat 200 Air Pak (gas)

Bobcat 200 Air Pak Diesel

Maximize available payload. Reduce weight by up to 272 kg (600 lb.) and increase available payload by up to 24 cubic feet by reducing the equipment on the truck.

Reduce fuel consumption. Minimize fuel costs by reducing truck engine idle time by as much as 75 percent, or if you have a separate engine-driven compressor by only operating one engine.

Minimize operating costs. Potentially save more than \$50,000 over ten years from increased fuel efficiency, decreased maintenance costs and increased asset life.

Advanced Auto-Speed™ technology automatically adjusts engine speed to match weld and battery charge demands – reducing fuel consumption, maintenance costs and noise for more efficient jobsites.

Industrial rotary-screw air compressor. Easily outperforms and outlasts reciprocating compressors. Many air tools can be powered by the compressor including most 19 mm (3/4 in.) impact wrenches. Immediately supplies 0.85 m³/min. (30 cfm) at 175 psi, 100 percent duty cycle, continuous air output.

210-amp welder. Maximize downtime and delays by making metal repairs in the field to stay on schedule.

6,500-watt generator power to support jobsite tools, lights, and high-demand applications like plasma cutters and TIG welders.

Battery charge/crank assist. Provides up to 100 amps at idle to quickly charge 12- and 24-volt batteries. Jobsite equipment with weak batteries can get up to 300 amps of crank assist.

Light industrial CC CV DC

Process

- Stick (SMAW) ■ MIG (GMAW)¹
- Flux-cored (FCAW)¹ ■ DC TIG (GTAW)²

¹With voltage-sensing feeder.

²Two-piece TIG torch recommended.

Engines

EFI gas: Kohler ECH730

23.5 hp at 3,600 rpm
Twin-cylinder, four-cycle, overhead valve, industrial, air-cooled

EPA Tier 4 Final Diesel: Kubota D722

19 hp at 3,600 rpm
Three-cylinder, industrial, liquid-cooled

Note: Engines are warranted separately by engine manufacturer.

Most popular accessories

- ArcReach® SuitCase® Feeders
- Spoolmate™ 200 300497
- Spoolmatic® 30A 13083
- Spectrum® 375 X-TREME™
- Multi-Terrain Running Gear 301460
- Full KVA Adapter Cord 300517
- Protective Cover
 - 301475 Gas without running gear
 - 301476 Gas with running gear
 - 301531 Diesel without running gear
 - 301532 Diesel with running gear
- HWY-Mid Frame Trailer 301438
- 25 ft. Battery Charge/Jump Cables with Plug 300422
- Air Compressor Oil Heater 301448
- Air Dryer Kit 301488
- Spool Gun Extension Hose and Cable Kit 132228

	Model/Stock Number	Welding Mode	Welding Process	Amp/Volt Ranges	Rated Weld Output at 40°C (104°F)	Single-Phase Generator Power at 40°C (104°F)	Dimensions	Net Weight
Gasoline	Bobcat 200 Air Pak (907771) Kohler	CC/DC	DC stick/TIG	30-210 A	120 A at 25 V, 100% duty cycle 140 A at 26 V, 60% duty cycle 210 A at 28 V, 20% duty cycle	Peak: 8,000 watts Continuous: 6,500 watts	H: 616 mm (24.25 in.) H: 756 mm (29.78 in.) to top of exhaust W: 508 mm (20 in.) D: 1,133 mm (44.61 in.)	233 kg (514 lb.)
		CV/DC	MIG/FCAW	15-26 V	120 A at 20 V, 100% duty cycle 140 A at 21 V, 60% duty cycle 210 A at 25 V, 20% duty cycle			
Diesel	Bobcat 200 Air Pak Diesel (907760) Kubota	CC/DC	DC stick/TIG	30-210 A	120 A at 25 V, 100% duty cycle 140 A at 26 V, 60% duty cycle 210 A at 28 V, 20% duty cycle	Peak: 8,000 watts Continuous: 6,500 watts	H: 734 mm (28.875 in.) H: 756 mm (29.75 in.) to top of exhaust W: 508 mm (20 in.) D: 1,200 mm (47.25 in.)	280 kg (618 lb.)
		CV/DC	MIG/FCAW	15-26 V	120 A at 20 V, 100% duty cycle 140 A at 21 V, 60% duty cycle 210 A at 25 V, 20% duty cycle			
	Rotocomp Air Compressor	Features			Free Air Delivery	Working Pressure	Duty Cycle	Oil Capacity
		Rotary screw with electric clutch for on/off, oil change intervals 500 hours			0.85 m ³ /min. (30 cfm) at 3,600 rpm	80-175 psig	100%	1.89 L (2 qt.)

REDEFINE *WHERE YOU WORK*

New Remote Solutions for Miller® Engine Drives



Save fuel



Lower jobsite
noise



Reduce time and
money on maintenance



Improve jobsite
safety



Remote Start/Stop

START & STOP *WHERE YOU WORK*

Take control and eliminate engine noise. Easily turn your machine on and off remotely, so it only runs when you need it.

Remote start/stop is standard on Bobcat™ 225 and Bobcat™ 260 gas and diesel welder/generators.



Wireless Interface Control

TOTAL CONTROL *WHERE YOU WORK*

You spoke. We listened. Now get full control of your machine in the palm of your hand from wherever you are on the jobsite and work hassle-free. Change welding processes, adjust parameters, select and save preset programs, turn the machine on/off, and more.

Wireless interface control is a factory-installed option on select Trailblazer® 325 and Big Blue® welder/generators.



Remote Output Panel Kit

ACCESS *WHERE YOU WORK*

Locate your engine drive's output panels at the point of use. Minimize the need to climb onto the truck to make connections and optimize payload space.

Remote output panel kit is compatible with Bobcat™, Trailblazer® and Big Blue® welder/generators.



Bobcat™ Series Gas, LP and Diesel



Reliable, powerful and durable –
the legendary Bobcat welder/generator.

Remote start/stop

Take control and eliminate engine noise. Standard on most models. Easily turn your Bobcat machine on and off remotely so it only runs when you need it. Get more out of each tank, extend time between maintenance and work without the hassle of walking back to your machine.



Savings on fuel and maintenance

Remote start/stop allows you to quickly turn off your Bobcat welder/generator when it is not in use. With fewer engine hours, you will spend less money on fuel and less time and money on maintenance.

SAVE
SAVE ON FUEL AND
MAINTENANCE BY SHUTTING
THE MACHINE OFF.

Easier and more reliable engine starts

Carbureted gas Bobcat welder/generators now have eChoke technology, which automatically sets the proper air/fuel mixture and eliminates the need to manually engage the choke, so cold-starting is now hands free.

eChoke is a trademark of Kohler Co.

**ECHOKE™
TECHNOLOGY**
FOR MORE CONSISTENT
COLD-WEATHER STARTS.

Less noise

Reduce the number of machines running on a jobsite and increase your awareness of potential warning sounds when you easily turn your Bobcat welder/generator off with remote start/stop.

0dB
WHEN YOU DON'T
NEED POWER,
TURN THE MACHINE
OFF REMOTELY.

Versatile AC and DC welding

Provides AC and DC welding output for greater versatility and quality welds on all types of metals. DC is smooth and easy to run while AC stick is used when arc blow occurs.

Compact design

Bobcat welder/generators can easily be moved around and take up less space, leaving more room on your truck for other equipment and tools.

Bobcat™ 225 (Gas) See literature ED/4.41

Cost-effective, multiprocess welder/generator primarily used for stick welding. Great for farm, ranch and maintenance/repair.

Features three DC stick/TIG controls, one AC stick/TIG control and one wire range for output control. Stick ranges designed for 2.4, 3.2 and 4 mm (3/32, 1/8 and 5/32 in.). Very easy to set.

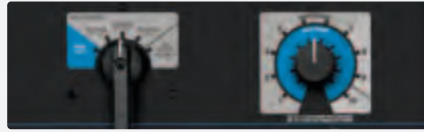

Bobcat™ 3 Phase (Gas) See literature ED/4.33

Designed for farm and ranch owners in need of single- and three-phase power to run 480-volt three-phase pivot irrigation systems or to provide backup power for farm and/or ranch.

Bobcat™ 260 (Gas, LP or Diesel) See literature ED/4.42

MOST POPULAR! Multiprocess welder/generator capable of carbon arc gouging features a larger stabilizer for less spatter and smoother arc. Ideal welder/generator for maintenance/repair, construction or farm/ranch.

Convenient front panel fuel gauge.

Precise amperage settings with wide range for optimal stick/flux-cored welding.

Features four AC/DC stick/TIG controls and two wire ranges for output control. Stick ranges designed for 2.4, 3.2, 4 and 4.8 mm (3/32, 1/8, 5/32 and 3/16 in.). Very easy to set.



Add optional electronic fuel injection (EFI) – improved fuel efficiency for maximum productivity and profitability

Adding EFI to your Bobcat 260 welder/generator provides multiple benefits. With EFI you'll get faster, more reliable starts in any weather – no choke adjustments needed. EFI-equipped Bobcat 260 machines are also up to 42 percent more fuel efficient than standard carbureted models, improving profitability. Plus, refueling less frequently means you'll spend more of your time welding, improving productivity.

*Electric fuel pump recommended for operation at altitudes above 1524 m (5,000 feet).

**For LP model order Hose and LP Tank Mounting Assembly (300917) separately.

Industrial

Processes

- AC/DC stick (SMAW)
- MIG (GMAW)¹ ■ Flux-cored (FCAW)¹
- AC²/DC TIG (GTAW)
- Air carbon arc cutting and gouging (CAC-A)³ (rated 4.8 mm [3/16 in.] carbons)

¹With voltage-sensing feeder.

²With Dynasty® 210 Series.

³Bobcat 260 models only.

Engines

Gas: Kohler CH730 with eChoke™

23.5 hp at 3,600 rpm

EFI gas: Kohler ECH730

23 hp at 3,600 rpm

LP: Kohler CH730

Liquid withdrawal LP system

21.5 hp at 3,600 rpm

V-twin-cylinder, four-cycle, overhead valve, industrial, air-cooled

EPA Tier 4 Final Diesel: Kubota D722

19 hp at 3,600 rpm

Three-cylinder, industrial, liquid-cooled

Note: Engines are warranted separately by engine manufacturer.

Most popular accessories

- ArcReach® SuitCase® Feeders
- Dynasty® 210 Series
- Spectrum® 625 X-TREME™
- Running Gear
- Protective Cage with Cable Holders
- Hose and LP Tank Mounting Assembly
- Remote Oil Drain/Filter Kit
- Full KVA Adapter Cord 300517
- Protective Cover
- Remote Output Panel Kit 951850
- HWY-Mid Frame Trailer
- Remote Start/Stop Fob Replacement 286385
- GFCI Panel Mount 120 VAC Duplex Kit 300975
- Electric Fuel Pump Kit 300976 (gas models only, recommended for operation at altitudes above 1524 m [5,000 ft.])
- Spark Arrestor Kit 300924 (gas models only)

	Model	Stock Number	Welding Mode	Welding Process	Amp/Volt Ranges	Rated Output at 40°C (104°F)	Generator Power at 40°C (104°F)	Dimensions	Net Weight
Gasoline	Bobcat 225	(907791001) Kohler (907791) Kohler with GFCI	CC/AC	Stick/TIG	60-160 A	150 A at 25 V, 100% duty cycle	Single-phase Peak: 11,000 watts Continuous: 9,500 watts	H: 711 mm (28 in.) H: 832 mm (32.75 in.) to top of exhaust W: 508 mm (20 in.) D: 1,029 mm (40.5 in.)	220 kg (485 lb.)
			CC/DC	Stick/TIG	40-225 A	225 A at 25 V, 100% duty cycle			
			CV/DC	MIG/FCAW	19-28 V	200 A at 20 V, 100% duty cycle			
Gasoline	Bobcat 3 Phase	Non-remote start/stop model (907505) Kohler with GFCI	CC/AC	Stick/TIG	40-225 A	200 A at 25 V, 100% duty cycle	Single-phase/three-phase Peak: 11,000 watts Continuous: 9,500/10,000 watts		225 kg (495 lb.)
			CC/DC	Stick/TIG	40-210 A	210 A at 25 V, 100% duty cycle			
			CV/DC	MIG/FCAW	19-28 V	200 A at 20 V, 100% duty cycle			
Gas or LP	Bobcat 260	(907792001) Kohler (907792) Kohler with GFCI (907792002) Kohler with electric fuel pump* (907793) EFI Kohler Non-remote start/stop model (907794**) LP Kohler with GFCI	CC/AC	Stick/TIG	40-260 A	260 A at 25 V, 60% duty cycle 225 A at 25 V, 100% duty cycle	Single-phase Peak: 11,000 watts Continuous: 9,500 watts EFI model Peak: 12,000 watts Continuous: 10,500 watts	H: 711 mm (28 in.) H: 832 mm (32.75 in.) to top of exhaust W: 508 mm (20 in.) D: 1,029 mm (40.5 in.)	227 kg (501 lb.)
			CC/DC	Stick/TIG	40-260 A	260 A at 25 V, 100% duty cycle			
			CV/DC	MIG/FCAW	17-28 V	275 A at 25 V, 60% duty cycle 260 A at 28 V, 100% duty cycle			
Diesel	Bobcat 260 Diesel	(907790) Kubota with GFCI	CC/AC	Stick/TIG	40-260 A	260 A at 25 V, 100% duty cycle	Single-phase Peak: 11,000 watts Continuous: 9,500 watts	H: 711 mm (28 in.) H: 873 mm (34.375 in.) to top of exhaust W: 508 mm (20 in.) D: 1,153 mm (45.375 in.)	289 kg (638 lb.)
			CC/DC						
			CV/DC	MIG/FCAW	17-28 V	275 A at 25 V, 60% duty cycle 260 A at 28 V, 100% duty cycle			

Trailblazer® Series Gas, LP and Diesel

See lit. ED/4.75 (Gas/LP) and ED/4.8 (Diesel)



Trailblazer 325 EFI with optional Excel power shown.

Trailblazer welder/generators deliver unbeatable arc performance providing the smoothest, most stable arc in the industry. Miller-exclusive Auto-Speed™ technology (now with 1,800 rpm level on diesel model) delivers superior runtimes, increased fuel efficiency, and improved welder/generator performance.

ArcReach® remote control technology

Standard on most models – remote control of the power source without a control cord.



An ArcReach system allows you to change weld settings from your ArcReach feeder or remote, saving a trip to the power supply. ArcReach technology uses the existing weld cable to communicate welding control information between the feeder or remote and the power source. This technology eliminates the need for control cords, and their associated problems and costs. Learn more at MillerWelds.com/arcreach

Unbeatable arc performance

Dynamic DIG™ technology automatically adjusts the amount of current required to clear a short. Delivers a smoother, more consistent arc that can be tailored to match the application, material, fit-up and welder technique.



Increased performance at high altitude

Electric fuel pumps are now standard on all EFI models leading to better performance when operating at altitudes of 5,000 feet or greater.

More productive jobsites

Quieter jobsites are more productive because work crews can communicate easier, and work can start earlier and end later – even in noise-sensitive areas.

Auto-Speed™ technology

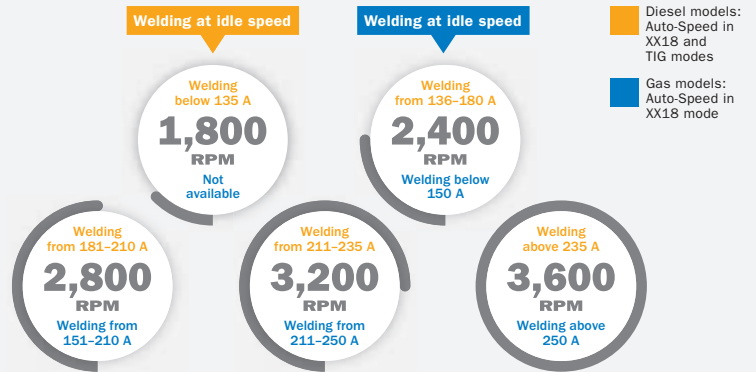

Get the welding power you need – plus reduced fuel consumption and lower noise levels for a more profitable jobsite. Trailblazer-exclusive Auto-Speed technology responds to weld requirements by automatically adjusting engine speed to a corresponding rpm level so the engine never works harder than necessary. Refueling time and operating costs are reduced, which means more productivity and profitability. Auto-Speed technology – available only from Miller.

Options to Maximize Your Trailblazer® 325 Performance

Electronic fuel injection (EFI) (gas models)

Adding EFI to your Trailblazer welder/generator adds multiple benefits. With EFI, you'll get faster, more-reliable starts in any weather – no choke adjustments needed. EFI-equipped Trailblazer machines are also up to 42 percent more fuel efficient than standard carbureted models, improving profitability. Plus, refueling less frequently means you'll spend more of your time welding, improving productivity.

Add Excel power to your Trailblazer with EFI for maximum fuel efficiency.

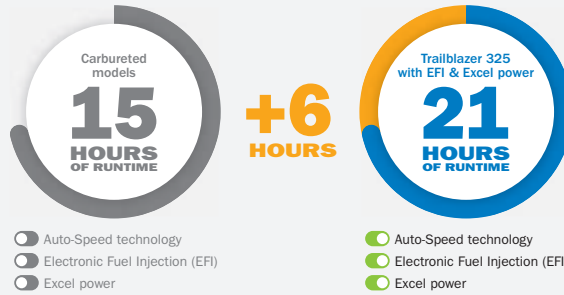

Based on typical usage – 150 amps welding 40% of the time; 20 amps generator power 30% of the time; and idling without load 30% of the time.

Excel™ power

Excel power delivers a full 2,400 watts (20 A) of 120-volt inverter-based, pure sine wave power at all speeds, including idle. Unlike competitive machines that provide auxiliary power only at 3,600 rpm (max), with Excel power you can operate jobsite tools like grinders at quiet, fuel-saving speeds.

Refueling time and operating costs are reduced with Excel power, which means more productivity and profitability. Plus everyone on the jobsite gets a better working environment because noise levels are lowered. Excel power – available only from Miller.

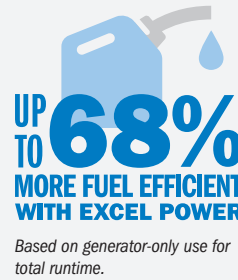

Battery charge/crank assist (gas models)

Reduce downtime with battery charge/crank assist capability. Designed and recommended for mechanics or anyone responsible for a fleet of trucks or equipment. By using your Trailblazer to charge dead batteries or jump a stubborn engine, you'll keep your crew working and the fleet up and running. Provides up to 75 amps of DC current to quickly charge 12- and 24-volt batteries. Jobsite equipment with weak batteries can get up to 350 amps of crank assist.

Note: Battery charge/jump cables (300422) must be ordered separately.

*Electric fuel pump recommended for operation at altitudes above 1,524 m (5,000 ft.).

**For LP models order Hose and LP Tank Mounting Assembly (300917) separately.

Heavy industrial

Processes

- Stick (SMAW) ▪ MIG (GMAW)¹
- Flux-cored (FCAW)² ▪ DC TIG (GTAW)²
- RMD³ ▪ Pulsed MIG (GMAW-P)³
- Air carbon arc cutting and gouging (CAC-A) (rated 4.8 mm [3/16 in.] carbons)

¹With wire feeder.

²Two-piece TIG torch recommended.

³ArcReach models only with ArcReach Smart Feeder.

Engines

Gas: Kohler CH730

23.5 hp at 3,600 rpm

EFI gas: Kohler ECH730

23 hp at 3,600 rpm

LP: Kohler CH730LP

23.5 hp at 3,600 rpm

Twin-cylinder, four-cycle, overhead valve, industrial, air-cooled

EPA Tier 4 Final Diesel: Kubota D902

24.8 hp at 3,600 rpm

Three-cylinder, industrial, liquid-cooled

Note: Engines are warranted separately by engine manufacturer.

Most popular accessories

- SuitCase® Feeders
- ArcReach® Smart Feeder⁴
- ArcReach® Stick/TIG Remote⁴
- ArcReach® Heater⁴
- Spoolmatic® 30A/WC-24 Control 130831/137549
- Running Gear
- Protective Cage with Cable Holders
- Hose and LP Tank Mounting Assembly
- Full KVA Adapter Cord
- Protective Cover
- Remote Output Panel Kit 951850
- HWY-Mid Frame Trailer
- Electric Fuel Pump Kit 300976 (gas models only, recommended for operation at altitudes above 1,524 m (5,000 ft.))
- 7.6 m (25 ft.) Battery Charge/Jump Cables with Plug 300422 (Trailblazer 325 EFI 907798004 only)
- Wireless Interface Control Screen Protectors 287594 (5 pack)

⁴For ArcReach models only.

	Model	Stock Number	Welding Mode	Welding Process	Amp/Volt Ranges	Rated Output at 40°C (104°F)	Single-Phase Generator Power at 40°C (104°F)	Dimensions	Net Weight
Gas or LP	Trailblazer 325	(907797) Kohler (907797001) Kohler with GFCI (907797002) Kohler with GFCI and electric fuel pump* (907798) EFI Kohler (907798002) EFI Kohler with Excel power (907775001**) Liquid LP Kohler with GFCI and Excel power	CC/DC	Stick/TIG	10-325 A (Gas) 10-305 A (LP)	325 A at 28 V, 100% duty cycle (Gas) 305 A at 28 V, 100% duty cycle (LP)	Peak: 12,000 watts 10,500 watts (LP) Continuous: 10,500 watts 10,000 watts (LP) Excel power (optional) 2,400 watts 20 A at 120 V, 60 Hz pure generator power at idle speed and while welding.	H: 711 mm (28 in.) H: 832 mm (32.75 in.) to top of exhaust W: 508 mm (20 in.) D: 1,029 mm (40.5 in.)	Gas: 209 kg (460 lb.) LP: 215 kg (475 lb.)
		CV/DC	MIG/FCAW	10-35 V					
Diesel	Trailblazer 325 Diesel	(907799) Kubota (907799001) Kubota with GFCI (907799002) Kubota with GFCI and Excel power (907799007) 325X, Kubota with International Receptacles, Excel power, and XX18 stick mode at 1800 RPM	CC/DC	Stick/TIG	10-325 A	325 A at 33 V, 100% duty cycle		H: 711 mm (28 in.) H: 876 mm (34.5 in.) to top of exhaust W: 508 mm (20 in.) D: 1,156 mm (45.5 in.)	281 kg (620 lb.)
		CV/DC	MIG/FCAW	10-35 V	325 A at 33 V, 100% duty cycle				

Trailblazer® 302 Air Pak™ See literature ED/4.78

Powerful all-in-one tool designed for repair and construction with multiprocess weld quality, generator power, air compressor and battery charge/jump start.



Superior arc performance. Preset dig settings optimized for the majority of stick welding applications, best-in-class wire arc performance, and two Lift-Arc™ TIG modes for most DC TIG applications.

Strongest combined generator/compressor power. Delivers an industry-leading 13,000 watts of peak generator power independent of weld settings – can power a Spectrum® 875 plasma cutter, and provide air for plasma cutting at the same time (rated 13 mm [1/2 in.] mild steel).

Rotary screw air compressor. Delivers up to 0.88 m³/min. (31 cfm) and 160 psi of air with no storage tank. Gives 100 percent deliverable air and runs many tools at idle speed. Air outputs are rated at an industry-high 40°C (104°F). Front panel air pressure adjustment and automatic overpressure shutdown with indication. Designed for more than 30,000 hours of operation and warranted for three years by Miller.

Battery charge/crank assist. Provides selectable 12- or 24-volt battery charging with up to 450 amps of battery crank assist capability. Convenient front panel access.

Note: Battery charge/jump cables (300422) must be ordered separately.

**Recommended for operation at altitudes above 1,524 m (5,000 ft.).*

Heavy industrial ● **CC** **CV** **AC** **DC**

Processes

- AC/DC stick (SMAW)
- MIG (GMAW)¹ ▪ Flux-cored (FCAW)²
- AC²/DC³ TIG (GTAW)
- Air carbon arc cutting and gouging (CAC-A) (rated 4.8 mm [3/16 in.] carbons, capable 6.4 mm [1/4 in.] carbons)

¹ With wire feeder.

² With Dynasty® 210 Series.

³ Two-piece TIG torch recommended.

Gasoline engine

Kohler CH750: 27 hp at 3,600 rpm V-twin-cylinder, four-cycle, overhead valve, industrial, air-cooled

Note: Engine is warranted separately by engine manufacturer.

Most popular accessories

- SuitCase® Feeders
- Spoolmatic® 30A Aluminum Spool Gun / WC-24 Control 130831 / 137549
- HWY-Mid Frame Trailer 301438
- 7.6 m (25 ft.) Battery Charge/Jump Cables with Plug 300422

Gasoline	Stock Number (907549001) Kohler (907549) Kohler with GFCI and electric fuel pump* (907549003) Kohler with GFCI, cooler/separator and electric fuel pump*	Welding Mode	Process	Amp/Volt Ranges	Rated Weld Output at 40°C (104°F)	Single-Phase Generator Power at 40°C (104°F)	Dimensions	Net Weight
		CC/DC	Stick/TIG	10-300 A	280 A at 32 V, 100% duty cycle	Peak: 13,000 watts Continuous: 11,000 watts	H: 711 mm (28 in.) H: 876 mm (34.5 in.) to top of exhaust W: 508 mm (20 in.) D: 1,514 mm (59.625 in.)	350 kg (771 lb.)
		CV/DC	MIG/FCAW	13-35 V, 350 A	300 A at 32 V, 100% duty cycle 350 A at 32 V, 60% duty cycle			
		CC/AC	Stick/TIG	10-225 A	200 A at 25 V, 60% duty cycle			
	Air Compressor	Features	Free Air Delivery		Working Pressure Constant	Duty Cycle	Oil Capacity	
		Rotary screw with electric clutch for on/off, oil change intervals of 500 hours	0.88 m ³ /min. (31 cfm) at 3,600 rpm 0.79 m ³ /min. (28 cfm) at 3,000 rpm 0.62 m ³ /min. (22 cfm) at 2,400 rpm (idle)		80-160 psig	100%	1.7 L (1.75 qt.)	

Big Blue® 400X Pro See literature ED/5.7

The professional welder's choice – designed with the professional in mind, the Big Blue 400X Pro is the best for ease of use, reliability and fuel economy.



ArcReach® Available on select models. Remote control of the power source without a control cord.

Tailored arc control (DIG) allows arc characteristics to be changed for specific applications and electrodes. Smooth running 7018 or stiffer, more penetrating 6010.

Industrial USB port. Quickly upload the latest software and download machine log files to retrieve in-depth information such as diagnostics and machine statistics.

10,000 watts of pure generator power. Plug in an extra Miller® inverter-based power source for an additional welding arc!

Quiet operation. Only 71.6 decibels (96 Lwa) under full load. Improves jobsite communication and safety.

Standard features include digital meters with SunVision™, automatic idle, adjustable Hot Start™, output contactor control and 120-volt block heater.

Heavy industrial ● **CC** **CV** **DC**

Processes

- Stick (SMAW) ▪ MIG (GMAW)
- Flux-cored (FCAW) ▪ DC TIG (GTAW)
- RMD® ▪ Pulsed MIG (GMAW-P)*
- Air carbon arc cutting and gouging (CAC-A) (rated 4.8 mm [3/16-in.] carbons)

**ArcReach models only with ArcReach Smart Feeder.*

Diesel engines

Kubota V1505: 20.2 hp at 1,800 rpm Four-cylinder, industrial, liquid-cooled

CAT C1.5: 21.7 hp at 1,800 rpm Three-cylinder, liquid-cooled

Note: Engines are warranted separately by engine manufacturer.

Most popular accessories

- ArcReach® SuitCase® Feeders
- ArcReach® Smart Feeder**
- ArcReach® Stick/TIG Remote**
- Dynasty® 210 Series
- Protective Cover 195301

***For ArcReach models only.*

Diesel	Stock Number (907732010) Kubota, CE (907732011) Kubota w/ArcReach, CE (90774002) CAT Turbo w/ArcReach	Welding Mode	Process	Amp/Volt Ranges	Rated Output at 40°C (104°F)	Single-Phase Generator Power at 40°C (104°F)	Dimensions	Net Weight
		CC/DC	Stick/TIG	20-400 A	300 A at 32 V, 100% duty cycle 350 A at 27 V, 100% duty cycle	Peak: 12,000 watts Continuous: 10,000 watts	H: 813 mm (32 in.) W: 667 mm (26.25 in.) D: 1,422 mm (56 in.)	Kubota 456 kg (1,003 lb.) CAT 500 kg (1,100 lb.)
		CV/DC	MIG/FCAW	14-40 V	400 A at 24 V, 100% duty cycle			

Big Blue® 500X Pro

See literature ED/11.0

Clean, quiet, multiprocess machines designed to give welders the output they need for heavy-duty applications on construction and fabrication sites.



ArcReach®

Remote control of the power source without a control cord.



Arc control is beneficial when welding with stick and solid wires for easier fine-tuning of tough-to-weld materials and out-of-position applications.

Industrial USB port. Quickly upload the latest software and download machine log files to retrieve in-depth information such as diagnostics and machine statistics.

Low OCV stick (VRD) for improved operator safety without compromising arc starts.

Auto Remote Sense™ (ARS) detects if a remote control is plugged into the 14-pin receptacle and eliminates confusion of a remote/panel switch.

15,000 watts of pure generator power. Plug in an extra Miller® inverter-based power source for an additional welding arc!

Standard features include digital meters with SunVision™, adjustable Hot Start™ output contactor control, automatic idle, thermal overload protection and 120-volt block heater.

Heavy industrial 

Processes

- Stick (SMAW) • MIG (GMAW)
- Flux-cored (FCAW) • DC TIG (GTAW)
- RMD®* • Pulsed MIG (GMAW-P)*
- Air carbon arc cutting and gouging (CAC-A) (rated 8 mm carbons)

*ArcReach models only with ArcReach Smart Feeder.

Diesel engine

Deutz D2011L03i

3-cylinder, industrial, air/oil-cooled

Note: Engines are warranted separately by engine manufacturer.

Most popular accessories

- ArcReach® SuitCase® 8/12
- ArcReach® Smart Feeder**
- ArcReach® Stick/TIG Remote**
- Dynasty 210® Series
- Full KVA Adapter Cord
- Full KVA Plug Kit
- Protective Cover 301495 301113
- HWY-225 Trailer 301338
- Wireless Remote Hand Control/ Wireless Antenna Kit 300430 / 300749
- Spark Arrestor Kit 195012

**For ArcReach models only.

Diesel	Stock Number	Welding Mode	Process	Amp/Volt Ranges	Rated Output at 40°C (104°F)	Generator Power at 40°C (104°F)	Dimensions	Net Weight
	(907788) Deutz with ArcReach	CC/DC	DC stick/TIG	20-500 A				
		CV/DC	MIG/FCAW	14-50 V				

Big Blue® 500X CC and 600X CC

See literature
ED/10.11

Designed for fleet owners that demand the ultimate in reliability and performance. Built with reliable, heavy-duty industrial components for operation in remote locations, without downtime.



Big Blue 600X CC shown.

Meter maintenance displays:

- Hour meter function and Oil change interval
- High coolant temperature and low oil pressure shutdowns
- Low fuel shutdown — engine shuts down before system runs out of fuel, making restarts easy

Enclosed robust case design protects internal components from impact and allows air flow to cool and prolong the life of the engine. Also reduces sound levels.

Hot Start™ provides positive stick electrode starts making it easy to start all types of electrodes and it also works great for bead tie-ins.

Arc-Drive™ makes welding easy. Automatically enhances stick welding, especially on pipe, by focusing the arc and preventing the electrode from going out.

5,500-watt peak AC power independent of weld settings means no interaction between tools and welding arc.

Quick and easy maintenance with single-side access to oil level check, oil fill, oil filter, fuel filter and air cleaner.

Heavy industrial ● CC DC

Processes

- Stick (SMAW)
- TIG (GTAW)
- Air Carbon Arc Cutting and Gouging (CAC-A) (500X: rated 8 mm [5/16 in.] carbons); (600X: rated 9.5 mm [3/8 in.] carbons)

Diesel engines

500X – Deutz D2011L03i

3-cylinder, industrial, air/oil-cooled

500X – Perkins 404D-22

4-cylinder, industrial, liquid-cooled

600X – Deutz D2011L04i

4-cylinder, industrial, air/oil-cooled

Note: Engines are warranted separately by engine manufacturer.

Most popular accessories

- Engine Filter Kits
 - Deutz 2011 246988
 - Deutz 912 246989
 - Perkins 404 246985
- Cold Weather Starting Aids available for all units
- Weld Meters 195131
- Battery Voltmeter 195454
- Spark Arrestor Kit 195012
- Protective Cover 194683
- RHC-3GD34A Remote Hand Control 041122

Model	Stock Number	Description	Process	Amp/Volt Ranges	Rated Output at 40°C (104°F)	Generator Output Rated at 40°C (104°F)	Shipping Weight
Big Blue 500 X CC	(907185) (907185001) with auto idle, V-A meters and battery meter	Deutz D2011L03i	DC, Stick/TIG	55-500 A	400 A at 36 V (14.4 kW), 100% duty cycle 450 A at 38 V (17.1 kW), 60% duty cycle 500 A at 30 V (15 kW), 40% duty cycle	Peak: 5500 watts Continuous: 4000 watts, 34/17 A, 120/240 VAC, 50/60 Hz while welding	907185: 728 kg (1604 lb.)
Big Blue 600 X CC	(907193) (907193001) with auto idle, V-A meters and battery meter	Deutz D2011L04i		65-600 A	500 A at 40 V (20 kW), 100% duty cycle 550 A at 34 V (18.7 kW), 60% duty cycle 600 A at 30 V (18 kW), 40% duty cycle		Deutz: 769 kg (1695 lb.)

Big Blue® 450 Duo CST™ See literature ED/5.5

Durable dual-operator welder/generator delivers proven CST stick/TIG performance with two superior arcs in one compact package, for maximum productivity and efficiency.



- Two separate outputs with Tweco®-style receptacles** deliver up to 280 amps of output per operator.
- Quiet operation.** At 72.1 decibels (97 Lwa) under full load, it's quieter than most single-operator models. Improves jobsite communication and safety.
- Vandalism lockout kit (not shown).** Lockable hinged steel panel protects front control panels and ignition switch.
- Simple-to-operate process selector knob automatically sets proper DIG setting** on E6010 and E7018 electrodes for superior stick performance.
- Lift-Arc™** start for TIG starts without the use of high frequency.
- Remote amperage control** permits the use of standard and wireless amperage control devices.
- Increased efficiency.** More arcs and better fuel economy equal increased profits for your business. Estimated savings are up to 34 percent with a dual-operator unit versus two single-operator units.

Heavy industrial ● **CC DC**

- Processes**
- Stick (SMAW) • DC TIG (GTAW)
 - Air carbon arc cutting and gouging (CAC-A) (rated 4.8 mm [3/16 in.] carbons)
- Diesel engine**
EPA Tier 4 Final
Mitsubishi S4L2: 24.7 hp at 1,800 rpm
 Four-cylinder, industrial, liquid-cooled
Note: Engine is warranted separately by engine manufacturer.
- Most popular accessories**
- Full KVA Adapter Cord 300517
 - Single-Phase Full KVA Plug Kit 119172
 - Protective Cover 195301
 - HWY-Mid Frame Trailer 301438
 - Spark Arrestor Kit 195012

Diesel	Stock Number	Process	Output Mode	Amperage Range	Rated Output at 50°C (122°F)	Single-Phase Generator Power at 50°C (122°F)	Dimensions	Net Weight
	(907477) Mitsubishi	DC stick/TIG	Separate (dual outputs)	5-225 (each side) 5-280 (one side only)	175 A at 27 V, 100% duty cycle	Continuous: 10,000 watts	H: 813 mm (32 in.) W: 667 mm (26.25 in.) D: 1,422 mm (56 in.)	483 kg (1,064 lb.)
		Paralleled (combined)	10-450	350 A at 27 V, 100% duty cycle				

Big Blue® 700X Duo Pro See literature ED/5.6

A complete multiprocess and multioperator welder/generator in one rugged package. Up to 400 amps of output per operator can be paralleled with a single switch to provide up to 800 amps of power.



ArcReach®

Remote control of the power source without a control cord.

- Two independent pipe quality arcs** in one compact package.
- Multiprocess CC/CV capability** provides independent operator controls and the best Stick, MIG, Flux-cored and TIG performance available with no interaction.
- Easy arc starts and better arc control** for best in class performance.
- Independent remote control connections** allow the use of standard and wireless volt/amperage control devices for each operator.
- Quiet operation.** At just 68 dB at idle or 76 dB at 7 m (23 ft.) at full load, it's quieter than many single-operator models, improving jobsite communication and safety.
- Smaller, lighter, quieter, and smoother running** than competitive models with comparable output.
- Standard features** include oil pan heater, intake manifold heater, output paralleling switch and automatic idle.
- Smart feeder compatible.** Advanced RMD® and pulsed MIG processes are now available in an engine-driven welder/generator. Discover increased productivity, quality, and improved efficiency in field welding.

Heavy industrial ● **CC CV DC**

- Processes**
- Stick (SMAW) • MIG (GMAW)
 - Flux-cored (FCAW) • TIG (GTAW)
 - Air Carbon Arc Cutting and Gouging (CAC-A) (rated 9.5 mm [3/8 in.] carbons)
 - RMD • Pulsed MIG (GMAW-P) with ArcReach Smart Feeder
- Diesel engine Deutz D2011L04i:**
 48.6 HP at 1800 RPM
 Four-cylinder, industrial, air/oil-cooled
Note: Engine is warranted separately by engine manufacturer.
- Most popular accessories**
- ArcReach® SuitCase®
 8: 301457 / 12: 301456 / 12RC: 301121
 - ArcReach® Smart Feeder 300935
 - ArcReach® Stick/TIG Remote 301325
 - Wireless Remote Hand Control/Wireless Antenna Kit 300430/300749
 - Spectrum® 875
 - Adapter Cord, Full KVA 300517
 - Full KVA Plug Kit: 1-Phase 119172
 3-Phase 254140
 - Protective Cover 194683
 - HWY-225 Trailer 301338
 - Engine Filter Kit 246988

Diesel	Stock Number	Welding Mode/Process	Output Mode	Amp Range	Rated Output at 40°C (104°F)	Generator Output Rated at 40°C (104°F)	Dimensions	Net Weight
	(907762) Deutz with ArcReach and Parallel Switch	CC/DC (Stick/TIG)	Separate (dual outputs)	20-400 A (each side)	300 A at 28 VDC, 100% duty cycle 400 A at 36 VDC, 40% duty cycle	Three-Phase: 20,000 watts continuous or Single-Phase: 12,000 watts continuous 380/400V Three-Phase Auxiliary Power	H: 1,092 mm (43 in.) W: 724 mm (28.5 in.) D: 1,654 mm (65.125 in.)	784 kg (1,729 lb.)
			Paralleled (combined)	40-800 A	500 A at 34 VDC, 100% duty cycle 700 A at 24 VDC, 60% duty cycle			
		CV/DC (MIG/FCAW)	Separate (dual outputs)	14-50 V (each side)	300 A at 28 VDC, 100% duty cycle 400 A at 34 VDC, 40% duty cycle			
Paralleled (combined)			14-50 V	500 A at 34 VDC, 100% duty cycle 700 A at 24 VDC, 60% duty cycle				

Big Blue® 800X Duo Air Pak™ See literature ED/13.0

The most powerful diesel welder/generator in the industry. Robust output for welding and power generation, and ideal for dual-operator applications on labor intensive jobsites, or jobsites with limited space.



ArcReach®

Remote control of the power source without a control cord.



Multi-arc welding. One dependable engine – two independent arcs with up to 400 amps each. Or plug in additional inverters for a true multioperator work platform! Example: Two additional XMT machines equals four operators, up to 200 amps each. Premium quality arcs allow operators to work independently with no arc interaction. Multioperator welding has never been easier or more versatile.

Increased efficiency. More arcs and better fuel economy equal increased profits for your business. Estimated savings are 34 percent with a dual-operator unit versus two single-operator units.

Simple paralleling switch makes switching from a single operator to dual operators a breeze. Weld up to 400 amps per side when set up in dual-operator mode, or up to 800 amps in single-operator mode.

Electronic engine display simultaneously displays fuel level, engine hours, coolant temperature, oil pressure, battery volts and engine rpm. Also tracks oil change intervals and displays engine diagnostics for easier servicing. Air Pak model adds air pressure and compressor hours displays.

Arc control is beneficial when welding with stick and solid wires for easier fine-tuning of tough-to-weld materials and out-of-position applications.

Industrial USB port. Quickly upload the latest software and download machine log files to retrieve in-depth information such as diagnostics and machine statistics.

20,000 watts of pure generator power. Plug in an extra Miller® inverter-based power source for an additional welding arc!

Standard features include digital meters with SunVision™ automatic idle, 120-volt block heater and vandalism lockout (protects control panel and receptacles, see photo at right).



Ingersoll Rand ultra-reliable industrial rotary screw compressor. 30,000-hour life expectancy. Independent on/off control for applications not requiring compressed air— allows greater fuel savings and longer compressor service intervals.

Heavy Industrial

Processes

- Stick (SMAW) • MIG (GMAW)
- Flux-cored (FCAW) • DC TIG (GTAW)
- RMD® • Pulsed MIG (GMAW-P)*
- Air carbon arc cutting and gouging (CAC-A) (rated 12.7 mm [1/2-in.] carbons)
- Stud (12.7 mm [1/2 in.]

*With ArcReach Smart Feeder.

Diesel engine

Deutz TD2011L04i

63.4 hp at 1,800 rpm

Turbo-charged, four-cylinder, industrial, air/oil-cooled

Note: Engines are warranted separately by engine manufacturer.

Most popular accessories

- ArcReach® SuitCase®
8: 301457 / 12: 301456 /
12RC: 301121
- ArcReach® Smart Feeder 300935
- ArcReach® Stick/TIG Remote 301325
- Dynasty 210® Series
- Full KVA Adapter Cord 300517
- Full KVA Plug Kit
119172 Single-phase
254140 Three-phase
- Protective Cover 301113
- HWY-225 Trailer 301338
- Four-Wheel Off-Road Trailer 042801
- Wireless Remote Hand Control /
Wireless Antenna Kit
300430/300749



Desiccant Air Dry System (Air Pak model only)

- 195117 Side mount
- 195117001 Rear mount
- Eliminates moisture in the air stream and prevents air line freeze-ups in cold climates.
- Spark Arrestor Kit 195012

*Welder truck specific models available – visit MillerWelds.com or your distributor.



Diesel	Stock Number*	Welding Mode/Process	Output Mode	Amp/Volt Ranges	Rated Output at 100% Duty Cycle at 40°C (104°F)	Generator Power at 40°C (104°F)	Dimensions	Net Weight
	(907763) Deutz with ArcReach	CC/DC (Stick/TIG)	Separate (dual outputs)	20–400 A	400 A at 36 V (each side)	Three-phase Peak: 27,000 watts Continuous: 20,000 watts 380/400V Three-phase auxiliary power	H: 1,168 mm (46 in.) W: 724 mm (28.5 in.) D: 1,765 mm (69.5 in.)	968 kg (2,095 lb.)
	CV/DC (MIG/FCAW)	Separate (dual outputs)	14–50 V	400 A at 34 V (each side)	Single-phase Peak: 15,000 watts Continuous: 12,000 watts			
		Paralleled (combined)	40–800 A	700 A at 44 V, 800 A at 38 V				
		Paralleled (combined)	14–50 V	750 A at 40 V, 800 A at 38 V				
	Ingersoll Rand CE55 G1 Air Compressor	Features	Free Air Delivery	Working Pressure Constant	Duty Cycle	Oil Capacity		
		Rotary screw with electric clutch for on/off, oil change intervals of 500 hours, life expectancy of 30,000 hours	Idle: 1.13 m ³ /min (40 cfm) Weld: 1.70 m ³ /min (60 cfm)	100 psig (7 bar)	100%	3.79 L (4 qt.)		

Miller offers an array of versatile submerged arc components, including power sources, controls, wire drives, torches, tractors and a variety of other accessories.

SubArc Digital Series See literature AD/7.3

The SubArc Digital Series of power sources, interface controls and accessories include digital control and communication electronics designed to improve weld performance and simplify the integration of the equipment in more advanced applications.



Heavy industrial ●
 **DC**  SubArc DC Series is DC only.

- Processes**
- Submerged arc (SAW)
 - Electroslag (ESW)
 - Air carbon arc cutting and gouging (CAC-A)
- Most popular accessories**
- 14-pin Insight Core™ Module 301072
Requires Insight Core to SubArc Digital Series Adapter Kit (301295).
 - ArcAgent™ Auto 301346
 - 4.6 m (15 ft.) SubArc Parallel Cable 260775015
 - 4.6 m (15 ft.) SubArc Tandem Cable 260878015

Two DC power source models and one AC/DC power source model. Power sources have sufficient power capacity to cover applications from traditional DC single-arc to multi-wire tandem welding. In the case of electroslag welding or other high-current demand, two or more power sources can easily be paralleled (both DC and AC/DC machines).

Low-voltage accessory operation and improved environmental protection. The Digital Series accessories are powered with 24 VAC control voltage from the power source. All power sources, interface controls and wire drives are IP23 rated providing a high level of protection for harsh environments.

Easy to integrate. Our SubArc power sources are easy to integrate by using a standard Modbus® connection.

All power sources also feature thermal overload protection, line voltage compensation and Fan-On-Demand.™

**While idling.*

Model/Stock Number	Amperage Range (CC Mode)	Voltage Range (Sub Arc Mode)	Rated Output	IP Rating	Amps Input at Rated Output, 50 Hz					Max Open-Circuit Voltage	Dimensions (Includes lift eye, but not strain relief)	Net Weight
					380 V	400 V	440 V	KVA	KW			
SubArc DC 650 Digital (907622) 230/460/575 V, 60 Hz SubArc DC 800 Digital (907623) 380/400/440 V, 50 Hz, CE	50-815 A	20-44 V	650 A at 44 V, 100% duty cycle	IP23	95 1.9*	90 1.8*	83 1.6*	50 1.52*	34.8 0.76*	75 Vpk	H: 762 mm (30 in.) W: 584 mm (23 in.) D: 965 mm (38 in.)	269 kg (593 lb.)
SubArc DC 1000 Digital (907624) 230/460/575 V, 60 Hz SubArc DC 1250 Digital (907625) 380/400/440 V, 50 Hz, CE	100-1,250 A	20-44 V	1,000 A at 44 V, 100% duty cycle	IP23	135 5.2*	128 5.0*	117 4.5*	73 3.2*	53 0.5*	68 Vpk		309 kg (682 lb.)
SubArc AC/DC 1000 Digital (907620) 460 V, 60 Hz SubArc AC/DC 1250 Digital (907621) 380/400 V, 50 Hz, CE	300-1,250 A	20-44 V	1,000 A at 44 V, 100% duty cycle	IP23	179 3.0*	176 3.0*	—	122 2.37*	67 0.95*	93 Vpk	H: 1,092 mm (43 in.) W: 711 mm (28 in.) D: 1,219 mm (48 in.)	538 kg (1,187 lb.)



SubArc Interface Control

See literature AD/7.3



Easier setup and operation. The SubArc Digital Series Interface controls recognize the power source and wire drive connected, and automatically configure the system for proper operation.

Internal terminal strip is able to integrate with positioners, sidebeams, turning rolls and other peripheral equipment.

Most popular accessories

- SubArc Control Cables
 - 260622030 9 m (30 ft.)
 - 260622050 15 m (50 ft.)
 - 260622060 18.3 m (60 ft.)
 - 260622080 24.4 m (80 ft.)
 - 260622100 30.5 m (100 ft.)
 - 260622120 36.6 m (120 ft.)
 - 260622200 61.0 m (200 ft.)

Model/Stock Number	Input Power from Welding Power Source	Welding Power Source Type	Dimensions	Net Weight
SubArc Interface Digital (300936), CE	24 VAC, 1-phase, 25 A, 50/60 Hz	Constant voltage (CV), AC or DC, with remote contactor and output control capabilities	H: 292 mm (11.5 in.) W: 305 mm (12 in.) D: 178 mm (7 in.)	7.2 kg (15.8 lb.)

SubArc Remote Operator Interface

See literature AD/7.3



Motor Control Digital



Remote Pendant Digital

Point-of-use installation. Remote Pendant can be handheld or secured at point of use to improve operation.

Remote installation. Motor Control can be remotely installed, resulting in reduced cables at the operator workstation.

Side handles on Remote Pendant provides option for handheld operation with full functionality of a traditional SubArc Interface.

Most popular accessories

- Continuum Control/Motor Cables
 - 263368015 4.6 m (15 ft.)
 - 263368025 7.6 m (25 ft.)
 - 263368050 15 m (50 ft.)
- SubArc Control Cables
 - 260622030 9 m (30 ft.)
 - 260622050 15 m (50 ft.)
 - 260622080 24.4 m (80 ft.)

Model/Stock Number	Input Power from Welding Power Source	Welding Power Source Type	Dimensions	Net Weight
SubArc Motor Control Digital (301425), CE (requires SubArc Remote Pendant Digital below and Continuum control/motor cable)	24 VAC, 1-phase, 25 A, 50/60 Hz	Constant voltage (CV), AC or DC, with remote contactor and output control capabilities	H: 292 mm (11.5 in.) W: 305 mm (12 in.) D: 178 mm (7 in.)	5.9 kg (13 lb.)
SubArc Remote Pendant Digital (301424), CE (requires SubArc Motor Control Digital above and Continuum control/motor cable)			H: 279 mm (11 in.) W: 270 mm (10.63 in.) D: 80 mm (3.125 in.)	1.4 kg (3 lb.)

SubArc Wire Drive 400 Digital Low Voltage

See literature AD/7.3

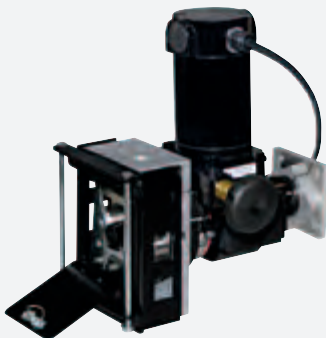

SubArc Wire Drive 400 Digital Low Voltage is a standard-speed, right-angle wire drive assembly.

Most popular accessories

- Motor Extension Cables
 - 254232005 1.5 m (5 ft.)
 - 254232010 3 m (10 ft.)
 - 254232025 7.6 m (25 ft.)
 - 254232065 19.8 m (65 ft.)
- Single-Wire Straightener 199733
- Twin-Wire Straighteners (for twin-wire torches only)
 - 301160 Single adjustment
 - 301162 Double/separate adjustment
- Drive Rolls
- Manual Slide

Model	Stock Number	Input Power	Input Power Cord	Rating	Wire Feed Speed	Wire Diameter Capacity	Net Weight
SubArc Wire Drive 400 Digital Low Voltage	(300938) Standard speed, CE	38 VDC	1.2 m (4 ft.)	1/5 hp, 85 rpm	0.8–10.2 mpm (30–400 ipm)	2.4–4.8 mm (3/32–3/16 in.)	11.8 kg (26 lb.)

SubArc Torches See literature AD/7.3

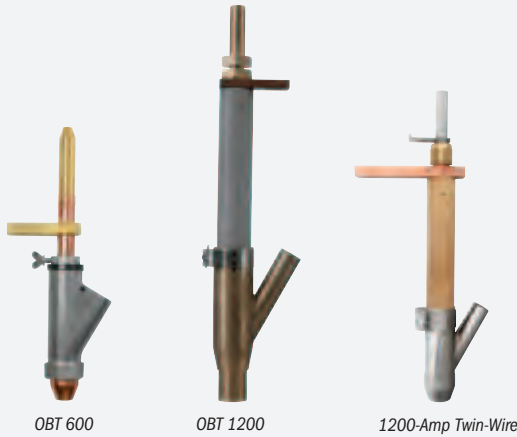

OBT 600 is a 600-amp, 100 percent duty cycle torch with concentric flux flow nozzle. Can be used with 1.6–4.0 mm (1/16–5/32 in.) wire.

OBT 1200 is a 1,200-amp, 100 percent duty cycle torch with concentric flux flow nozzle. Can be used with 1.6–4.8 mm (1/16–3/16 in.) wire. OBT 1200 features a replaceable breakaway adapter end to prevent costly damage should torch run into an obstruction.

1200-Amp Twin-Wire Torch (long) is a 1,200-amp, 100 percent duty cycle torch. For use with 1.2–2.4 mm (3/64–3/32 in.) wire.

Most popular accessories

- OBT 600 Torch Body Extensions
043967 25.4 mm (1 in.)
043969 50.8 mm (2 in.)
043973 101.6 mm (4 in.)
043975 152.4 mm (6 in.)
- OBT 1200 Torch Body Extension
043981
- Contact Tips

Model/Stock Number	Rated Output	Wire Diameter Capacity	Single/Twin	Torch Body Length
OBT 600 (043923)	600 A at 100% duty cycle	1.6–4.0 mm (1/16–5/32 in.)	Single	260.4 mm (10.25 in.)
OBT 1200 (043900)	1,200 A at 100% duty cycle	1.6–4.8 mm (1/16–3/16 in.)	Single	438.2 mm (17.25 in.)
1200-Amp Twin-Wire Torch (301144) Long	1,200 A at 100% duty cycle	1.2–2.4 mm (3/64–3/32 in.)	Twin	431 mm (16.97 in.)

SubArc 3-Wheel Tractor See literature AD/7.7



Easy-to-use foot- or hand-operated clutch allows for easy engagement of tractor drive and disengagement to move tractor into position.

Flexible mast configuration allows torch to be positioned in multiple weld zones and adapts to your weld application.

SubArc Tractor Interface Digital provides easy-to-operate single control for power source and tractor operation.

Regulated travel speed ensures your actual and set travel speeds are consistent, improving weld quality.

Locking front wheel can be set in place to desired travel path.

Easily accommodates a 27 kg (60 lb.) wire reel for fewer time-consuming wire changeovers.

Low-voltage operation and improved environmental protection. The new digital series accessories are powered with 24 VAC control voltage from the power source. All power sources, interface controls and wire drives are IP23 rated providing a high level of protection for harsh environments.

Required system components (sold separately)

- SubArc 3-Wheel Tractor 301446
- SubArc Tractor Interface Digital 301423
- SubArc Wire Drive 400 Digital Low Voltage 300938002
- 4.5 kg (10 lb.) capacity flux hopper with manual valve 301445
- 27 kg (60 lb.) wire reel 108008
- OBT 600 torch 043923
- Wire straightener 199733

Required power source

- SubArc Digital Series

Most popular accessories

- SubArc Control Cables
- Contact Tips
- Drive Rolls

Model/Stock Number	Input Power from Welding Power Source	Wire Feed Speed	Wire Diameter Capacity	Gun Positioning Slides	Drive Motor	Travel Speed	Dimensions	Net Weight
Digital 3-Wheel Tractor (301466) Subarc Tractor Interface (301423) Subarc Flux Hopper Manual (301445)	24 VAC, 1-phase, 50/60 Hz, 25 A	0.8–10.2 mpm (30–400 ipm)	1.6–4.0 mm (1/16–5/32 in.)	88.9 mm (3.5 in.)	38 VDC	0.13–1.75 m/min. (5–70 ipm)	H: 914 mm (36 in.) W: 1,149 mm (43.25 in.) D: 803 mm (31.63 in.)	54.4 kg (120 lb.) without flux or wire



Submerged Arc

SubArc Flux Hopper

See literature AD/7.3



Improved flux delivery system. Our SubArc Flux Hopper Digital Low Voltage utilizes a flux valve mechanism that assures continuous delivery of flux to the arc.

Sight glass allows the weld operator to visually monitor the remaining flux in the hopper.

Versatile opening is sized to allow hook-up of any flux-hopper-mounted recovery system.

Includes slag screen to capture fused slag particles from entering the flux hopper.

Most popular accessories

- Flux Hopper Extension Cables
260623010 3 m (10 ft.)
260623025 7.6 m (25 ft.)
260623065 19.8 m (65 ft.)

Stock Number	Input Power	Input Power Cord	Flux Capacity	Net Weight
SubArc Flux Hopper Digital Low Voltage (300942)	12 VDC (PWM signal from SubArc Interface)	3.3 m (11 ft.)	11 kg (25 lb.)	5 kg (11 lb.)

SubArc Portable Welding System

See literature AD/7.6



SubArc DC 650
Digital portable
system shown.

Self-contained system for pressure vessel, pipe and general welding applications. Houses a power source, column and boom on a mobile platform.

Built-in fork pockets and caster wheels allow welding system to be brought to the joint.

Easy positioning of the weld head through use of integrated motorized column, manual telescoping boom, slide and 360-degree column rotation.

Motorized column with pendant control and manual telescoping boom provides 1,117 mm (44 inches) of vertical travel and 787 mm (31 inches) of horizontal travel respectively.

Manual slide provides 200 mm (7.87 inches) of fine vertical and horizontal torch adjustment.

Systems include

- Portable column and boom
- SubArc Digital power source
- SubArc Interface Digital and control cable
- SubArc Wire Drive 400 Digital Low Voltage
- 11.3 kg (25 lb.) capacity flux hopper with valve
- 27 kg (60 lb.) wire reel and support assembly
- OBT 600 torch (650 system) or OBT 1200 torch (1000 system)
- Wire straightener
- Manual slide

Most popular accessories

- 14-pin Insight Core™ Module 301072
Requires Insight Core to SubArc Digital Series Adapter Kit (301295)
- Insight ArcAgent™ Auto 301346
- Contact Tips
- Drive Rolls

Stock Number	Supply Voltage	Column Stroke	Column Travel	Boom Stroke	Boom Travel	Base Rotation	Overall Height
(301133004) Column and Boom only with International packing	120 V, 1-phase, 60 Hz	1,117 mm (44 in.)	Constant speed	787 mm (31 in.)	Manual	360°	2,590 mm (102 in.)

ProHeat™ Induction Heating

Induction heating is a simple and cost-effective heating process that can deliver fast and consistent heat. Applications that would typically require hours to heat can be done in minutes.

- Welding fabrication and construction
- Preheating of welds
- Post-weld heat treatment (PWHT)
- Hydrogen bake out
- Shrink fit applications

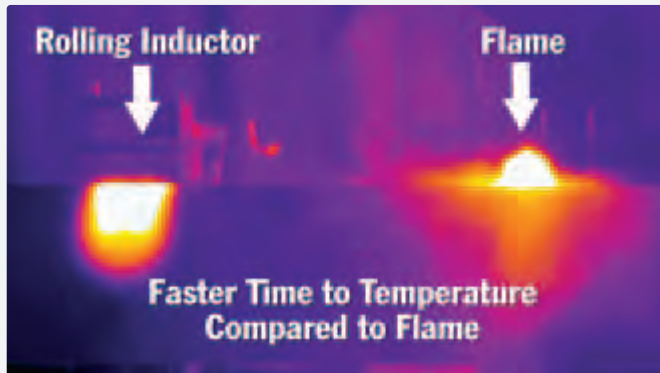

Induction heating solves many key issues in today's environment.

- Does not produce the exposure to burns associated with open flames and electrical resistance wires (only the work part becomes hot)
- No significant expense of fuel gases
- Produces fewer fumes than flame heating
- Produces less particulate from overheated insulation caused by high-temperature electrical wires and ceramic pads

Induction heating applications:

- | | | | |
|--------------------|--------------|-----------------|----------------|
| ▪ Process piping | ▪ Refinery | ▪ Petrochemical | ▪ Power piping |
| ▪ Pressure vessels | ▪ Structural | ▪ Shipbuilding | ▪ Pipeline |



To learn more:

Contact your distributor or regional ITW Welding office

ProHeat 35 Power Source

The ProHeat 35 induction power source is equipped with a built-in temperature controller allowing for manual or temperature-based programming using up to four control thermocouples. At more than 90-percent efficiency, the ProHeat 35 power source transfers more energy to the part, reducing operating costs over different heating methods.

Digital Recorder (optional)

The digital recorder is commonly used in stress relieving and critical preheat applications. The recorder stores temperature data based on time. It is not required to perform successful heating applications.

Heavy-Duty Induction Cooler (optional)

Optimized for induction heating applications, cooler features a 9.5 L (2.5 gal.) rustproof polyethylene tank, high-pressure pump and blower to yield a high cooling capacity.



ProHeat 35 power source shown with optional heavy-duty induction cooler, running gear and digital recorder.

Note: Primary input cable is not included with power source.



One ProHeat™ System – Four Basic Induction Heating Configurations

ProHeat 35 induction heating systems solve preheating, post weld heat treatment (PWHT) and stress relieving problems.

Liquid-Cooled Cables See literature IN/15.0

Preheat applications up to 788°C (1,450°F).

- A highly versatile tool for preheating, stress relieving, hydrogen bakeout, post weld heat treatment and shrink fit in a variety of pipe diameters and flat plate
- Designed with flexibility in mind, the ProHeat liquid-cooled induction heating cables can be wrapped into coils of various shapes and sizes to fit almost any induction heating application



Liquid-Cooled Rolling See literature IN/13.0

Preheat of moving parts up to 315°C (600°F).

- Ideal for preheating rolling pipe and moving parts, with easy and time-saving setup and movement for maintaining and adhering to preheat and interpass temperatures
- Enables the benefits of rolled pipe welding while also addressing some of the concerns associated with other popular heating methods, such as open flame and resistance heating
- *Optional* infrared temperature sensor can read the temperature on the moving part from 100–400°C (212–750°F)
- *Optional* travel detect system can be used for setting different heating rates/ ramps based on workpiece speed travel – when no movement is detected the system turns off the output preventing damage to workpiece and rolling inductor



Air-Cooled Blankets See literature IN/14.0

Preheating applications up to 204°C (400°F).

- Air-cooled blankets are available for pipe diameters from 20–152 cm (8–60 in.) or in the case of plate, the lengths are 1–5.2 m (41–205 in.)
- The blankets easily conform to circular and flat parts and install in a matter of seconds
- Manufactured from durable high-temperature materials, flexible induction blankets are designed to withstand the tough conditions in both industrial and construction applications



Air-Cooled Cables See literature IN/14.0

Preheating applications up to 200°C (392°F).

- Air-cooled cables are available in lengths of 9.1 m (30 ft.), 15.2 m (50 ft.) or 24.4 m (80 ft.) for flexible configurations
- Designed with flexibility and efficiency in mind, the air-cooled cables can be wrapped into coils of various shapes and sizes to fit almost any induction preheating application, without the need for cooler and coolant
- Air-cooled cables provide the same flexibility as liquid-cooled cables for preheating



ArcReach® Heater Air-Cooled Induction System

See literature IN/16.0

Field preheat and bakeout applications up to 315°C (600°F).



ArcReach Heater



Air-cooled cable

Air-cooled quick wrap

ArcReach Heater systems allow economical insured weld preheating and bakeout. The induction heating tools (air-cooled cables or air-cooled quick wraps) connect to the ArcReach Heater, which is powered by select on-site welding power sources. With ArcReach Heater systems you can:

- Eliminate the costly overruns common with heating contractors
- Eliminate delays due to transitions between heating and welding crews
- Run your own schedule without depending on third-party contractors
- Use existing on-site welding equipment up to 61 m (200 ft.) away as the heating power source
- Lower preheating and bakeout costs
- Automatically and accurately document joint temperatures
- Eliminate safety concerns caused by traditional resistance and open-flame heating

Easy setup with flexibility to fit a variety of pipe diameters, plates or odd geometries.

Time-to-temperature is faster than conventional processes due to the method of applying heat, reducing cycle time.

Uniform heating is maintained along and through the heat zone by using induction heat within the material. The surface of the part is not marred by localized conducted heat at higher than specified temperatures.

Improved working environment during welding. Welders are not exposed to open flames, explosive gases and hot elements associated with fuel gas heating and resistance heating.

ArcReach Heater is equipped with built-in temperature control allowing for either manual or computer-loaded programming using up to six thermocouples. It can run either one or two heating tools (air-cooled cable or air-cooled quick wrap) at the same time. Requires ArcReach Heater extension cable to operate.

Air-cooled cables are designed with flexibility and efficiency in mind. Cables can be wrapped into coils of various shapes and sizes to fit any induction preheat or bakeout application (flat plate, pipe, odd geometries).

Air-cooled quick wraps provide a fast and easy way to wrap a pipe joint (up to 254 mm [10 in.] diameter) for preheat and bakeout. Simply place around the pipe, connect the ends, and cinch the clip as close to the pipe as possible.

Durable high-temperature materials. Air-cooled cables and quick wraps are designed to withstand the tough conditions in both industrial and construction applications.

Preheat and bakeout programs can be manually entered or loaded via USB drive.

Heating data is automatically recorded and can be used in quality control and documentation needs.

Industrial

Process

- Induction heating

Suggested power sources

- XMT® 350 FieldPro
- Trailblazer® Series (ArcReach models only)
- Big Blue® Series (ArcReach models only)

Most popular accessories



- **ArcReach Heater Extension Cable** 301451 3 m (10 ft.)
- **Air-Cooled Quick Wrap** 301452
- **Air-Cooled Cable** 301453030 9.1 m (30 ft.) 301453050 15.2 m (50 ft.) 301453080 24.4 m (80 ft.)
- **Cable Cover** 204611 9.1 m (30 ft.) 204614 15.2 m (50 ft.) 204620 24.4 m (80 ft.)

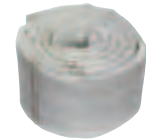

Preheat Insulation

- 204669 1.3 x 15 x 305 cm (1/2 x 6 x 120 in.)
- 195376 1.3 x 15 x 610 cm (1/2 x 6 x 240 in.)
- 211474 1.3 x 31 x 305 cm (1/2 x 12 x 120 in.)

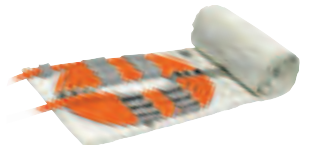

Preheat Insulation w/Cable Harness

- 301334 1.3 x 41 x 305 cm (1/2 x 16 x 120 in.)
- Series Cable Adapter 195437
- High-Temperature Rope 194965
- Temperature Measurement (two options available) Contact Thermocouple Sensor (Probe) 301517 **OR** welded on thermocouples which requires 152 m (500 ft.) Thermocouple Wire 194999, Thermocouple Connectors (10 pack) 195098, and Thermocouple Attachment Unit 194959

Stock Number	Input Power	Output Current	Output Voltage	Source Current	Output Frequency	Rated Output	Heater Dimensions	Heater Net Weight
(301390) Heater only (requires ArcReach Heater extension cable to operate) (301591) Heater only, CE	Operates on open-circuit voltage: 50-70 V provided by an XMT 350 FieldPro or ArcReach-equipped engine drive	200 A	300 V	33 A	5-30 kHz	7.8 kW at 100% duty cycle	H: 472 mm (18.6 in.) W: 285 mm (11.2 in.) D: 678 mm (26.7 in.)	20 kg (43 lb.)

Spectrum® Series Plasma Cutters

Our Spectrum line of plasma cutters provides big cutting power in portable packages and with features like flexible cables and Auto-Refire technology they are better than ever. Step up to Spectrum 625 X-TREME™ or 875/875 Auto-Line™ models to add Ultra-Quick Connect hand-held torches. Machine torch capabilities are available with Spectrum 875/875 Auto-Line™ models only.



Spectrum 375 X-TREME

Spectrum 625 X-TREME

Spectrum 875

Spectrum 875 Auto-Line

Spectrum Features

Feature	375	625	875	875 Auto-Line
	X-TREME			
Auto-Line (120-240 V)	●	●		
Auto-Line (208-575 V)				●
MVP™ plugs/adapters	●	●		
Ultra-Quick Connect torch with flexible cable		●	●	●
Quick connect flexible work cable with clamp	●	●	●	●
Built-in gas/air filter and regulator	●	●	●	●
Auto-Refire	●	●	●	●
Auto postflow	●	●	●	●
Auto air regulation	●	●	●	●
X-CASE™	●	●	●	●
Machine torch capable		●	●	●

Steel/Stainless/Aluminum Rated Cutting Capacity

Spectrum	375 X-TREME		625 X-TREME		875/875 Auto-Line
	Steel/Stainless	Aluminum	Steel/Stainless	Aluminum	Steel/Stainless
	9.5 mm (3/8 in.)	6.4 mm (1/4 in.)	15.9 mm (5/8 in.)*	9.5 mm (3/8 in.)	22.2 mm (7/8 in.)
				15.9 mm (5/8 in.)	

*Stainless: 12.7 mm (1/2 in.) for Spectrum 625 X-TREME.

Cut capacity ratings are based on traveling speed of approximately 381 mm (15 in.) per minute to achieve a precise cut. This is the key rating that should meet or exceed your typical cutting thickness requirements. Factors that can affect actual cut speeds, thickness capacity and duty cycles are: types of thermally conductive material being cut, available input power, output power settings and operator technique. For highly thermal conductive metals such as aluminum, cutting capacities may be reduced up to 30 percent compared to mild steel.

Power factor correction (PFC). Uses less energy by utilizing input power more efficiently and increases productivity by reducing nuisance circuit breaker trips.

LED indicators for easy troubleshooting.

Non-high-frequency arc starting does not interfere with or damage controls or computers.

Postflow cooling circuitry extends life of the consumable and torch by cooling them with postflow air after trigger is released.

Auto-Refire™ provides ultimate convenience by automatically controlling the pilot arc when cutting expanded metal or multiple pieces of metal.

Built-in gas/air filter and regulator. Provides air filtration of airborne particles five microns and larger. Additional filtration and water separation recommended.

LVC™ line voltage compensation provides peak performance power under variable input voltage conditions for clean, steady cuts.

Wind Tunnel Technology™ prevents abrasive dust and particles from damaging internal components.

Fan-On-Demand™ cooling system only operates when needed, reducing the amount of airborne dust/dirt pulled through the unit.

Quick connect flexible work cable with heavy-duty clamp.

Spectrum 625 X-TREME and 875/875 Auto-Line hand-held and machine torches

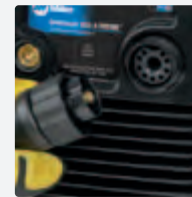

Ultra-Quick Connect™ hand-held torches with flexible cables.

XT40 (625 X-TREME) and XT60 (875 models) hand-held torches feature quick torch connection,

ergonomic handles to help prevent operator fatigue and flexible cables that make maneuvering easier.



Machine torch capable.

625 X-TREME and both 875 models can be ordered with a machine torch or can be converted to use a machine torch with optional automation kits.

Long and short body machine torches. XT40M (625 X-TREME) and XT60M (875 models) machine torches are available in long or short body configurations. XT60M is also available in 7.6 or 15.2 m (25 or 50 ft.) cable lengths.

Models/packages



Spectrum 375 X-TREME hand-held torch package (907529) shown.



Spectrum 875 Auto-Line machine torch package (907584002) shown.

Model	Hand-Held Torch Packages			Long Body Machine Torch Packages	
	3.7 m (12 ft.)	6.1 m (20 ft.)	15.2 m (50 ft.)	7.6 m (25 ft.)	15.2 m (50 ft.)
Spectrum 375 X-TREME	(907529)	—	—	—	—
Spectrum 625 X-TREME	(907579)	(907579001)	—	—	—
Spectrum 875	—	(907583)	(907583001)	(907583002)	—
Spectrum 875 Auto-Line	—	(907584)	(907584001)	(907584002)	(907584004)

Spectrum® 375 X-TREME™/625 X-TREME™

See literature PC/9.2 (375 X-TREME) and PC/9.6 (625 X-TREME)

AUTO-LINE TECHNOLOGY Allows for any input voltage hook-up (120–240 V, single-phase, 50/60 Hz for 375 X-TREME and 60 Hz for 625 X-TREME) with no manual linking, providing convenience in any job setting.

X-CASE™ provides the ultimate protection during transport and storage. Additional space is ideal for MVP plugs, consumables box, gloves, etc.

Multi-voltage plug (MVP™) on 375 X-TREME or MVP™ adapter on 625 X-TREME allows connection to 120- or 240-volt receptacles without tools.

Automatic air regulation compensates for input pressure variation to provide constant recommended torch pressure for optimum cutting performance.

Automatic gouging consumable detection (625 X-TREME only). Detects gouging consumable and adjusts gas pressure to optimize performance, eliminating the need for a manual regulator.



Spectrum 625 X-TREME shown.

375 X-TREME model includes XT30 hand-held torch with ergonomic design and flexible cable.

625 X-TREME model includes Ultra-Quick Connect™ XT40 hand-held torch with ergonomic design and flexible cable; or **XT40M long body or short body machine torch.**

Spectrum® 875/875 Auto-Line™

See literature PC/9.8

AUTO-LINE TECHNOLOGY **Spectrum 875 Auto-Line model** allows for any input voltage hook-up (208–575 V, single- or three-phase) with no manual linking, providing convenience in any job setting. *Standard Spectrum 875 model operates on 208/230 V, single-phase input voltage only.*

Consumables storage compartment provides convenient access to consumables and parts.

Automatic air regulation compensates for input pressure variation to provide constant recommended torch pressure for optimum cutting performance.



Spectrum 875 shown.

Includes Ultra-Quick Connect™ XT60 hand-held torch with ergonomic design and flexible cable; or **XT60M long body or short body machine torch.**

Light industrial ● 375/625 models
Industrial ● 875 models

DC 3 1 Only 875 Auto-Line has 3-phase capabilities.

Processes

- Air plasma cutting
- Air plasma gouging (625/875 models)

375 X-TREME package comes complete with

- XT30 hand-held torch with 3.7 m (12 ft.) cable
- Heavy-duty work clamp with 3.7 m (12 ft.) flexible cable
- 3 m (10 ft.) power cord with MVP 5-15P (120 V, 15 A) and 6-50P (240 V, 50 A) plugs
- X-CASE for protection and storage
- Shoulder strap
- Consumables box with two electrodes, two tips, deflector and air fitting

625 X-TREME packages come complete with

- XT40 hand-held torch with 3.7 m (12 ft.) or 6.1 m (20 ft.) cable
- OR XT40M long body or short body machine torch with 7.6 m (25 ft.) cable
- Heavy-duty work clamp and flexible cable with quick connect
- 3.7 m (12 ft.) power cord with 240 V, L6-30P twist lock plug
- MVP adapters with 5-15P (120 V, 15 A) and 6-50P (240 V, 50 A) plugs
- X-CASE for protection and storage
- Shoulder strap
- Consumables box with two electrodes, two 40 A tips and one 30 A tip, 30 A drag shield, deflector and air fitting
- Machine torch packages include corresponding automation kit

875 and 875 Auto-Line packages come complete with

- XT60 hand-held torch with 6 m (20 ft.) or 15.2 m (50 ft.) cable
- OR XT60M long body or short body machine torch with 7.6 m (25 ft.) or 15.2 m (50 ft.) cable
- Heavy-duty work clamp and flexible cable with quick connect
- 3 m (10 ft.) power cord
- Extra consumables
- Machine torch packages include corresponding automation kit

Most popular accessories

- Automation Kits
- Cables and Cable Covers
- Cutting Guides
- Filters
- Plugs and Cords
- Protective Covers/Cases
- Torches
- Torch Consumables

Model	Input Power	Rated Output at 40°C (104°F)	Amps Input at Rated Output	KVA	KW	Compressor Requirement	Dimensions	Net Weight with Torch
Spectrum 375 X-TREME 120–240 V, 50/60 Hz	Single-phase	120 V (15 A): 20 A at 88 VDC, 35% duty cycle	18.1	2.2	2.1	142 L/min. (5.0 cfm) at 621 kPa (90 psi)	H: 229 mm (9 in.) W: 140 mm (5.5 in.) D: 337 mm (13.25 in.)	8.6 kg (19 lb.)
		120 V (20 A): 27 A at 91 VDC, 20% duty cycle	25.6	3.1	3.0			
		240 V: 30 A at 92 VDC, 35% duty cycle	13.6	3.3	3.1			
Spectrum 625 X-TREME 120–240 V, 60 Hz	Single-phase	120 V (15 A): 20 A at 88 VDC, 35% duty cycle	18.1	2.2	2.1	170 L/min. (6.0 cfm) at 621 kPa (90 psi)	H: 229 mm (9 in.) W: 140 mm (5.5 in.) D: 337 mm (13.25 in.)	3.7 m (12 ft.) 9.5 kg (21 lb.) 6.1 m (20 ft.) 10.5 kg (23 lb.) 7.6 m (25 ft.) 10.7 kg (24 lb.)
		120 V (20 A): 27 A at 91 VDC, 20% duty cycle	25.6	3.0	2.9			
		240 V: 40 A at 140 VDC, 50% duty cycle	13.6	6.4	6.3			
Spectrum 875 208/230 V, 50/60 Hz	Single-phase	208 V: 60 A at 140 VDC, 40% duty cycle	208 V: 47	9.9	9.8	191 L/min. (6.75 cfm) at 621 kPa (90 psi)	H: 343 mm (13.5 in.) W: 222 mm (8.75 in.) D: 470 mm (18.5 in.)	6.1 m (20 ft.) 22.2 kg (49 lb.) 15.2 m (50 ft.) 26.3 kg (58 lb.)
		230 V: 60 A at 140 VDC, 50% duty cycle	230 V: 42					
Spectrum 875 Auto-Line 208–575 V, 50/60 Hz	Three-phase	208 V: 60 A at 140 VDC, 40% duty cycle	208 V: 27.5	9.9	9.4			6.1 m (20 ft.) 24.5 kg (54 lb.) 7.6 m (25 ft.) 25.4 kg (56 lb.) 15.2 m (50 ft.) 28.6 kg (63 lb.)
		230–380 V: 60 A at 140 VDC, 50% duty cycle	230 V: 25					
		380–575 V: 60 A at 140 VDC, 60% duty cycle	380 V: 15					
Spectrum 875 Auto-Line 208–575 V, 50/60 Hz	Single-phase	460 V: 12.4	460 V: 12.4	9.9	9.7			
		575 V: 9.8	575 V: 9.8					
Spectrum 875 Auto-Line 208–575 V, 50/60 Hz	Single-phase	208 V: 60 A at 140 VDC, 40% duty cycle	208 V: 47.4	9.9	9.7			
		230 V: 60 A at 140 VDC, 40% duty cycle	230 V: 42.2					
		230 V: 50 A at 140 VDC, 100% duty cycle						



Respiratory

Designed for comfort

Well-balanced design reduces torque on neck, increasing all-day wear.

Patent-pending Dualtec™ manifold system optimizes helmet balance and sound, while **six-point air distribution system** maximizes cooling through targeted air placement.

Ergonomic headgear provides secure fit without the need for over-tightening.

Lightweight low-profile blower assembly with integrated shoulder straps (PAPR) reduces lower back strain and fatigue.

Lightweight versatile C50 air regulator (SAR) can be positioned horizontally or vertically to naturally align with body movements.

Superior visibility

ClearLight™ Lens Technology optimizes contrast and clarity in welding and light states, easing eye strain.

Shade 5.0 side windows and oversized clear grind shield maximize downward and peripheral visibility, improving sense of surroundings.

Half-shade lens adjustability provides fine shade adjustment for optimized comfort and vision.

Improved productivity

Enhanced comfort, cooling and visibility maximize all-day wearability – increasing productivity, safety and regulatory compliance.

Low-profile breathing-tube attachment eases on/off process while flexible tube material reduces breathing tube snags in work cell.

Two lightweight lithium-ion batteries (PAPR) included with each package eliminate downtime.

C50 air regulator (SAR) supplies down to 28°C (50°F) Grade-D air under your hood, heightening productivity and relieving heat stress. Performance under different applications may vary. 360-degree swivel air hose connection alleviates hose coiling, reducing potential trip hazards.



T94-R

T94i-R

PAPR Powered Air-Purifying Respirator

See literature AY/4.1

Available packages:

With T94-R™ helmet (external grind control)

264573 With auto-darkening lens assembly

With T94i-R™ helmet (integrated clear grind shield)

264575 With auto-darkening lens assembly

T94-R™ helmet upgrade kit (for use with existing PAPR system)

279870 Includes T94-R helmet assembly, breathing tube, breathing tube cover and flowmeter

T94i-R™ helmet upgrade kit (for use with existing PAPR system)

279871 Includes T94i-R helmet assembly, breathing tube, breathing tube cover and flowmeter

A complete PAPR system consists of blower assembly, HEPA filter, prefilters (6), spark guard, breathing tube, breathing tube cover, padded belt, comfortable shoulder straps, lithium-ion batteries (2), battery charger, flowmeter, tool bag and helmet assembly (see available packages at left).

- HEPA filter provides up to 99.97 percent filtration of airborne particles
- NIOSH 42 CFR 84 certified, assigned protection factor of 25



Coiled air hose

Straight air hose

SAR Supplied Air Respirator

See literature AY/4.3

Available packages:

With T94i-R™ helmet (integrated clear grind shield)

264871 With auto-darkening lens assembly (air hose not included)

T94i-R™ helmet upgrade kit (for use with existing SAR system)

279871 Includes T94i-R helmet assembly, breathing tube, breathing tube cover and flowmeter



Also available

BreatheAir™ Portable Box

275983 Two person, 10 ppm alarm

275985 Four person, 10 ppm alarm
Supplies Grade-D breathing air while monitoring for CO.

Monitor Calibration Kit

275988 10 ppm

A complete SAR system consists of C50 air regulator, belt assembly, flowmeter, breathing tube, breathing tube cover, tool bag, T94i-R helmet assembly and air hose (see available packages at left).

- NIOSH 42 CFR 84 certified, assigned protection factor of 25. To provide a NIOSH-approved respiratory system, the SAR with T94i-R must be used with Miller® helmet, hoses, connectors, filters and other components recommended by the manufacturer



Respiratory



Face Shield PAPR Powered Air Purifying Respirator

See literature AY/4.2

288356 Complete System

This system consists of blower assembly, HEPA filter, prefilters (6), spark guard, breathing tube, breathing tube cover, padded belt, comfortable shoulder straps, lithium-ion batteries (2), battery charger, flowmeter, tool bag and face shield assembly with clear shield.

- HEPA filter provides up to 99.97 percent filtration of airborne particulate
- System is NIOSH 42 CFR 84 certified, assigned protection factor of 25 with standard head seal

Well-balanced design reduces torque on neck, increasing all-day wear.

Patent-pending Dualtec™ manifold system optimizes balance and sound, while **six-point air distribution system** maximizes cooling through targeted air placement.

Ergonomic headgear provides secure fit without the need for over-tightening.

Lightweight low-profile blower assembly with integrated shoulder straps reduces lower back strain and fatigue.

Enhanced comfort, cooling and visibility maximize all-day wearability – increasing productivity, safety and regulatory compliance.

High-Definition View (HDV) technology for a sharp detailed view at any angle with minimal distortion.

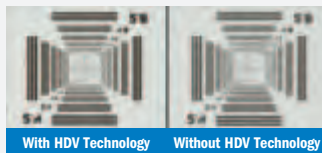

Low-profile breathing-tube attachment eases on/off process while flexible tube material reduces breathing tube snags in work cell.

Two lightweight lithium-ion batteries included with each system eliminate downtime.



LPR-100 OV
with P100/OV filters



LPR-100
with P100 filters

LPR-100™ OV Half Mask Respirator See literature AY/4.5

ML00996 Respirator with P100 organic vapor filters (small/medium)

ML00997 Respirator with P100 organic vapor filters (medium/large)

Filters and accessories

SA00820 P100/OV filters (one pair)

285686 Protective hard carrying case

261086 Quantitative fit-test kit adapter

- Low-profile design fits under T94™ and Digital Elite™ welding helmets and provides maximum field of vision
- P100/OV filters provide up to 99.97 percent filtration of specific organic vapors and airborne particulates
- NIOSH 42 CFR 84 certified, assigned protection factor of 10

LPR-100™ Half Mask Respirator See literature AY/4.5

ML00894 Respirator with P100 filters (small/medium)

ML00895 Respirator with P100 filters (medium/large)

ML00994 Respirator with P100 nuisance level OV relief filters (small/medium)

ML00995 Respirator with P100 nuisance level OV relief filters (medium/large)

Filters and accessories

SA00818 P100 filters (one pair)

SA00819 P100 nuisance level OV relief filters (one pair)

283374 Protective hard carrying case

261086 Quantitative fit-test kit adapter

- Low-profile design fits under T94™, Digital Elite™ and Classic welding helmets and provides maximum field of vision
- P100 filters provide up to 99.97 percent filtration of airborne particles
- Nuisance level OV relief filters are designed for use with organic vapor concentrations not exceeding OSHA's PELs or other applicable government occupational exposure limits, whichever is lower
- NIOSH 42 CFR 84 certified, assigned protection factor of 10

SHARE YOUR PASSION.

REVIEWS & RATINGS OFFER VALUABLE INSIGHTS TO HELP GUIDE YOUR NEXT PURCHASE.

Reviews are written and submitted by people who have purchased and used Miller® equipment. If you'd like to share your experience and help your fellow welders select the right welding equipment consider writing a review. Simply visit the product page on the website for the product you want to write about and click on "Write a Review".

VISIT NOW AT MillerWelds.com

Welding Helmets



Serious dependability backed with a three-year warranty.

	T94i™	T94™	Digital Infinity™	Digital Elite™	Digital Performance™	Classic VSI™	Classic VS	Classic FS#10 Flip-Up
Viewing Area	9 sq. in.	9 sq. in.	Largest Viewing Area 13.4 sq. in.	9.2 sq. in.	7.2 sq. in.	5.9 sq. in.	6 sq. in.	5.1 sq. in.
Auto-Darkening	Yes	Yes	Yes	Yes	Yes	Yes	Yes	Yes
ClearLight™ Lens Technology	Yes	Yes	Yes	Yes	Yes	Yes	Yes	Yes
AutoSense™	—	—	Yes	Yes	—	—	—	—
Shades	Cut: 5-8 Weld: 8-13	Cut: 5-8 Weld: 8-13	Cut: 5-8 Weld: 8-13	Cut: 5-8 Weld: 8-13	Cut: 5-8 Weld: 8-13	Weld: 8-13	Cut: 5-8 Weld: 8-13	10
Modes	Weld/Cut/X-Mode/ Flip grind	Weld/Cut/X-Mode/ External grind	Weld/Cut/X-Mode/ Grind	Weld/Cut/X-Mode/ Grind	Weld/Cut/ Grind	Weld/X-Mode/ Flip grind	Weld/Cut/ Grind	Weld/ Flip grind
Integrated Grind Shield	Yes	—	—	—	—	Yes	—	Yes
Auto-on	Yes	Yes	Yes	Yes	Yes	Yes	Yes	Yes
Sensors	4	4	4	4	3	3	2	2
TIG Rating	3 amps	3 amps	5 amps/below	5 amps/below	5 amps	5 amps/below	5 amps/below	20 amps
Switching Speed	1/20,000 second	1/20,000 second	1/20,000 second	1/20,000 second	1/20,000 second	1/20,000 second	1/23,000 second	1/3,600 second
Digital Controls	Yes	Yes	Yes	Yes	Yes	—	Yes	—
Premium Headgear	Yes	Yes	Yes	Yes	Yes	—	—	—
InfoTrack™	Yes - 2.0	Yes - 2.0	Yes - 1.0	—	—	—	—	—
Weight	737 g (26 oz.)	599 g (21 oz.)	652 g (23 oz.)	510 g (18 oz.)	482 g (17 oz.)	652 g (23 oz.)	454 g (16 oz.)	396 g (14 oz.)
Warranty	3 years	3 years	3 years	3 years	3 years	3 years	3 years	3 years

See chart above for feature availability.

ClearLight™ Lens Technology provides high-definition optics for precision arc recognition.

AutoSense™ reduces issues related to setting helmet sensitivity by allowing the welder to push and hold the AutoSense button to automatically set the helmet sensitivity for their environment.

X-Mode™ Electromagnetically senses the weld to reduce sunlight interference and continuously detects the arc even if sensors are blocked.

InfoTrack™ data monitoring technology tracks arc time and features a clock. Version 2.0 adds arc count.

T94™ Series Maximized comfort, visibility and productivity for the professional welder. See literature AY/41.1



Industry's largest integrated grind shield (44 sq. in)

T94i™
260483

Matte silver finish reflects ambient heat, keeping the user cooler.

Four operating modes for ultimate versatility: weld, cut, grind and X-Mode.™

Half-shade settings for precise lens adjustment.

Simplistic digital lens interface allows for easy adjustment with or without gloves.

Shade 5.0 side windows enhance peripheral vision, amplifying sense of surroundings.



External grind control

T94™
260482

Chiseled shell design provides optimal skin coverage while easily accommodating a Miller® Half Mask Respirator.

Gen IV premium headgear with four-point flexible design provides a secure fit, while avoiding major pressure points within the head, maximizing all-day wear. Customizable fit with seamless tilt, distance and tightness adjustments.

InfoTrack™ 2.0 monitors arc time and arc count.

Best-in-class comfort for all-day wearability

Lightweight, well-balanced design reduces neck torque, minimizing operator fatigue and strain, leading to an increase in comfort.



4% LIGHTER for reduced fatigue



14% BETTER BALANCE for elevated comfort



17% LESS TORQUE for reduced neck strain

Statistics above compare T94i to previous model.

Helmet Lighting Accessory 281361

- Provides additional lighting in low-light environments for T94 welding helmets
- Includes two lights (one for each side) and all required mounting hardware





Digital Infinity™ Series Largest viewing area maximizes visibility. See literature AY/42.0



Black
280045, CE

Black Ops™
280047, CE

Departed™
280048, CE

Stars and Stripes™
280049, CE

Relic™
280051, CE

Imperial™
280053

Digital Elite™ Series Industry-leading helmet provides high-performance versatility. See literature no. AY/43.0



Black
281000, CE

Lucky's Speed Shop™
281001, CE

Stars and Stripes™ III
281002, CE

Inferno™
281003, CE

Vintage Roadster™
281004, CE

Raptor™
281007, CE

Gear Box™
281009

Digital Performance™ Series See literature AY/44.0

Lightweight helmet with superior headgear for ultimate comfort.



Black
282000, CE

Blue Rage™
282001, CE

'64 Custom™
282002, CE

Crusher™
282005

Helmet Lighting Accessory 282013

- Provides additional lighting in low-light environments for most Miller® welding helmets including Titanium™, Infinity, Elite, Performance, Classic and MP-10
- Includes two lights (one for each side) and all required mounting hardware



IMPROVED! Classic Series Helmets for the value-minded welder.

All VS models now feature ClearLight™ Lens Technology. See literature AY/45.5 (VS) and AY/45.0 (VSi and FS#10 Flip-Up)



Black (VS)
287803, CE

Metalworks™ (VS)
287810, CE

Rise™ (VS)
287815, CE

Liberty™ (VS)
287820

Metal Matrix™ (VS)
288519

VSi™
287794

FS#10 Flip-Up
287798

MP-10™



Black
238497

Best-in-class traditional passive shade 10 lens helmet.

Welding Helmet Accessories



Slotted Hard Hat Adapter 259637

- Compatible with most slotted hard hats. Helmet and hat not included



Hard Hat Adapter 265315

- For T94™ welding helmets
- 222003** For Titanium™, Infinity™, Elite™, Performance™, Classic and MP-10™ welding helmets
- Compatible with most Fibre Metal and MSA hats. Other brands may fit depending on size and shape. Helmet and hat not included



IMPROVED!

Now features ClearLight™ Lens Technology.

2x4 Auto-Darkening Lens

- 287828** Shade 9
- 287830** Shade 10
- 287833** Shade 11
- Fits all 2x4-inch windows
- Solar powered
- Two arc sensors
- Two-year warranty

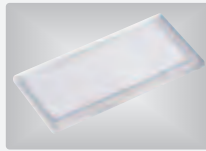

Magnifying Lens

- 212235** 0.75 magnification
- 212236** 1.00 magnification
- 212237** 1.25 magnification
- 212238** 1.50 magnification
- 212239** 1.75 magnification
- 212240** 2.00 magnification
- 212241** 2.25 magnification
- 212242** 2.50 magnification
- 4.25 x 2 x 5/23 inch lens for all Miller® helmets



Helmet Bib 253882

- Flame-resistant WeldX™ material provides additional neck coverage for the Infinity, Elite, Performance, Classic and MP-10 welding helmets



Helmet Bib 279078

- Flame-resistant material provides additional neck coverage for the T94 welding helmets



Helmet Cape 279080

- Flame-resistant material provides additional head and back-of-the-neck coverage for the T94 welding helmets



Helmet Hook 251018

- Holds welding helmets, grinding shields or other helmets with a headgear
- Silicone strap secures the helmet in place



Jobsite Tool Bag 228028

- Over twenty separate pockets
- Opening of 305 x 470 mm (12 x 18.5 in.)

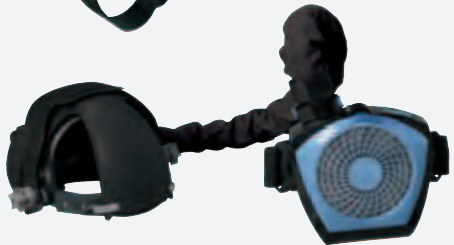

CoolBelt™ Belt-Mounted Cooling System 245230

- Up to **17 degrees Fahrenheit cooler** under the hood
- Provides all-day comfort through maximized airflow power
- Multiple airflow speeds eliminate stagnant air and reduce fogging
- Lightweight design extends wearability
- Compatible with Infinity, Elite, Performance, Classic and MP-10 welding helmets

Weld-Mask™ See literature AY/40.0



Compact auto-darkening lenses allow users to weld in spaces where access with traditional welding helmets is limited. Close-fitting soft eye covering provides total darkness for precision welding. Face shield and flame-retardant head cover provide coverage for UV/IR rays and applications with limited spatter.



Weld-Mask 267370

- Shades 5, 7, 9, 11 and 13 for use with MIG, TIG, stick, and gas welding and cutting
- Extremely lightweight (227 g [8 oz.]), virtually eliminates neck strain

Weld-Mask 2 280982

- Ideal for industrial or construction environments – can be worn under a hard hat with a Miller® Half Mask Respirator and select safety glasses
- Shades 5–13 for use with MIG, TIG, stick, and gas welding and cutting
- X-Mode™ electromagnetically senses the weld to reduce sunlight interference and continuously detects the arc even if sensors are blocked
- Wide, singular lens provides unmatched auto-darkening range of visibility



Weld-Mask 2 Lighting Accessory 281188

- Snaps onto brow of Weld-Mask 2 model to provide additional lighting in low-light environments

Weld-Mask Hard Hat Adapters 285757

- Snaps onto sides of most slotted hard hats to secure Weld-Mask

Safety Glasses See literature AY/46.0



- Anti-fog coating and high-quality optics
- Form-fitting orbital eye coverage
- Shatterproof polycarbonate lenses
- Wrap-around designs meet ANSI side shield requirements
- ANSI Z87.1+ compliant
- I/O (indoor/outdoor) lenses feature light shading with a mirrored finish
- Shade 3 and 5 IR lenses are for cutting, brazing or soldering

Safety and Cutting Glasses Chart

Frame Style (Color)	Clear Lenses	I/O Lenses	Shade 3 Lenses	Shade 5 Lenses
Classic (Black)	272187	–	–	–
Spatter™ (Black)	272191	–	–	–
Spark™ (Black/Blue)	272190	–	–	–
Slag™ (Black)	272201	272202	–	272205
Gen I (Black)	–	–	235662	235658



Face Shield Series

See literature AY/46.5



Face Shield

- 288269 Clear
- 288274 Clear + Anti-Fog
- 288270 Shade 3
- 288273 Shade 5

- HDV technology for a sharp detailed view at any angle without distortion
- Impact-resistant shield for increased durability and protection
- Lightweight design for all-day wear and comfort
- Clear + Anti-Fog lens coating prevents fogging for enhanced visibility
- Shade 3 and 5 lenses provide protection for cutting, brazing or soldering applications
- Made of polycarbonate material that provides 99.9 percent UVA/UVB/UVC protection to help prevent eye damage
- ANSI Z87.1 compliant



Halo Hard Hat Adapter
222003

Slotted Hard Hat Adapter
Clips (not shown) 259637

Welding Gloves

See literature AY/47.0

Performance – exceptional comfort and performance combined with dexterity and flexibility.



Heavy-Duty MIG/Stick

- Strategically placed patches on palm and back for extended glove life
- Double-layered insulated palm and back
- Pig grain leather palm provides extreme durability and protection

MIG (Lined)

- Dual-padded palm
- Fleece-insulated palm, foam-insulated back
- Cow grain palm, pig split back and goat grain inner fingers provide exceptional dexterity and comfort

TIG

- Completely unlined for heightened feel and dexterity
- Triple-padded palm for added comfort
- Goat grain leather offers superior flexibility and dexterity

TIG/Multitask

- Dual-padded palm for added comfort
- Wool back provides ultimate insulation
- Goat grain leather offers superior flexibility and dexterity

Metalworker

- Durable top grain leather and spandex back for enhanced durability and dexterity
- Neoprene wrist with hook-and-loop closure increases fit and support
- Padded, reinforced palm and thumb saddle for extended wear

Classic – traditional design for the value-minded welder.



Heavy-Duty MIG/Stick

- Reflective insulation on back reduces heat impact
- Moisture-wicking fleece and foam insulation
- Pig grain palm, pig split back and cuff

MIG (Pigskin)

- Reinforcement patches enhance durability
- Moisture-wicking fleece and foam insulation
- Pig split leather palm, back and cuff

MIG (Cowhide)

- Reinforcement patches enhance durability
- Moisture-wicking fleece and foam insulation
- Cow split palm, pig split back and cuff

TIG

- Thin internal padding for added comfort
- Unlined palm for precise dexterity
- Sheep grain palm, cow split back and cuff

Work

- Dual-padded palm for added durability
- Fleece back provides ultimate insulation
- Cow grain leather offers superior durability and abrasion resistance

NEW! Cut-resistant – exceptional comfort, performance and protection.



- ANSI A5 cut rating, level 4 puncture and abrasion rating, and level 3 heat rating
- Designed with pre-curved fingers for ergonomic fit and exceptional comfort
- Ergonomic wrist design for additional comfort
- Goat grain palm, cow split back and cuff, with Kevlar® flame-resistant thread
- 2-millimeter foam lining and mylar back for additional protection (MIG)
- Drag patch for enhanced durability (TIG)

Welding Glove Size Chart *All asterisked stock numbers are sold as one pair. All others are sold as six packs (six pairs).

Performance	Small	Medium	Large	X-Large	2X-Large	Classic	Medium	Large	X-Large	Cut-Resistant	Small	Medium	Large	X-Large	2X-Large
Hy-Duty MIG/Stick	–	–	263339	263340	269615*	Hy-Duty MIG/Stick	–	271877*	271887*	MIG	290412*	290413*	290414*	290415*	290416*
MIG (Lined)	–	263332	263333	263334	269618*	MIG (Pigskin)	–	279875*	279876*	TIG	290401*	290402*	290403*	290404*	290411*
TIG	263346	263347	263348	263349	–	MIG (Cowhide)	–	271890*	271891*						
TIG/Multitask	263352	263353	263354	263355	–	TIG	279897*	279898*	279899*						
Metalworker	–	251066	251067	251068	–	Work	266041*	266042*	266043*						



Welding Apparel

See literature AY/47.5



Grain Leather Jacket (See size chart)

- Top-grain pigskin leather
- Expandable leather strategically placed for optimal mobility
- Flame-resistant inside cuff
- Satin lining
- Tapered, athletic cut
- Sewn entirely with Kevlar® thread, adding structural durability at each seam



Split Leather Jacket (See size chart)

- Premium pig split leather
- Extended rear tail for additional protection
- Expandable leather strategically placed for optimal mobility
- Mesh lining
- Sewn entirely with Kevlar® thread, adding structural durability at each seam



WeldX™ Jacket (See size chart)

- 7-ounce WeldX front and flame-resistant navy cotton back
- Lightweight exclusive material with extreme flame-resistant properties
- Vented back/extended rear tail
- Zipper closure with hook-and-loop fastened flap
- Chromium free for easy disposal



Combo Jacket (See size chart)

- 9-ounce Indura® flame-resistant cotton (flame resistance guaranteed for life of jacket)
- Top-grain leather
- Pre-shrunk fabric



Indura® Cloth Jacket (See size chart)

- 9-ounce Indura® flame-resistant cotton (flame resistance guaranteed for life of jacket)
- Pre-shrunk fabric



Classic Cloth Jacket (See size chart)

- 9-ounce flame-resistant navy cotton
- Pre-shrunk fabric
- Fold-in sleeve snaps
- Finished hems and reinforced stitching



Leather Bib/Apron 231125

- Attaches to combo jacket with snaps across the chest as a bib or along the bottom as an apron



Combo Sleeves 231096

- Indura® flame-resistant cotton/top-grain leather
- .5 m (21 in.) length



Classic Cloth Sleeves 247148

- .46 m (18 in.) length
- Fold-in sleeve snaps
- Upper arm elastic band



Classic Cloth Apron 247149

- .9 m (35 in.) length with accessible front pocket
- Adjustable drawstring ensures a good fit

Welding Apparel Size Chart

Apparel	Small	Medium	Large	X-Large	2X-Large	3X-Large	4X-Large	5X-Large
Grain Leather Jacket	—	—	231090	231091	231092	—	—	—
Split Leather Jacket	273212	273213	273214	273215	273216	273217	273218	273219
WeldX Jacket	247114	247115	247116	247117	247118	247119	247120	247121
Combo Jacket	—	231081	231082	231083	231084	—	—	—
Indura Cloth Jacket	—	258097	258098	258099	258100	—	—	—
Classic Cloth Jacket	244749	244750	244751	244752	244754	244755	244756	244758



For more detailed information, visit

MillerWelds.com/arcstation

Count on Miller to design the perfect workbench to make welding projects faster and easier. The ArcStation is the first-ever, all-in-one workstation designed for welding and metalworking. It's versatile, affordable and just the right height to work comfortably. You can organize equipment, tools, and raw materials into one convenient workspace.

ArcStation™ 60SX Fully Loaded

The 60SX Fully Loaded is perfect for the welder who needs a tough workbench for the fab shop or the home garage.



60SX Fully Loaded

.76 x 1.52 m (30 x 60 in.) size tabletop provides double the work surface of the 30FX.

9.5 mm (3/8 in.) X-pattern steel tabletop allows trouble-free clamping.

Durable 3.2 mm (1/8 in.) steel frame with cross bar and heavy-duty tabletops provide a sturdy area for welding or metalworking.

Adjustable leveling feet keep workbench rock-steady.

Comes customized with a wide range of handy accessories to make this the *ultimate* workbench (see at right for replacement accessories).

ArcStation 60SX accessories

Miller® ArcStation accessories allow you to get the most out of your ArcStation.

- 1 6-inch X-clamp** 300613
- 2 Side Shelf** 300680
- 3 Tool Chest with ball-bearing slides** 300610
- 4 5-inch Quick-Remove Vise with mount** 300611
- 5 Weld Curtain** 300686
- 6 Casters** 300849



Convenience Kit 300614
Includes the following:

- 7 Gun holder**
- 8 Tool holder**
- 9 Clamp bar**

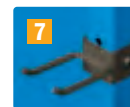

Popular system components

- Steel frame 1.52 m (60 in.) 300604
- Dust tray 300605
- Table top solid .76 x .76 m (30 x 30 in.) 300606
- Table top X pattern .76 x .76 m (30 x 30 in.) 300607

ArcStation™ 30FX

When portability or space-savings is a concern, the ArcStation 30FX is your solution.



30FX shown with two 152 mm (6 in.) X-clamps (sold separately).

Wheels, handle, and fold-up design make unit easy to take to the jobsite or move around the shop.

Compact size makes storing unit a breeze. Unit folds down to 152 x 737 x 1219 mm (6 x 29 x 48 in.).

.76 x .76 m (30 x 30 in.) size tabletop provides plenty of work surface.

4.8 mm (3/16 in.) X-pattern steel tabletop allows trouble-free clamping.

38.1 mm (1.5 in.) diameter steel tube frame provides strength and durability.

Includes removable gun holder.

Add optional 152 mm (6 in.) X-clamp (300613) to make this the *ultimate* portable workbench.

Model/Stock Number	Steel Top	Load Capacity	Dimensions	Weight
60SX				
30FX (300837)	(1) 737 x 737 x 4.8 mm (29 x 29 x 3/16 in.) X-pattern	227 kg (500 lb.)	889 x 737 x 889 mm (35 x 29 x 35 in.)	34 kg (74 lb.)



From our FREE OpenBook™ training software, to our MobileArc™ and AugmentedArc® augmented reality welding systems and LiveArc™ welding performance management system, we provide solutions to meet all of your welding training needs.

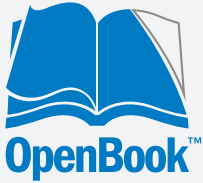

OpenBook provides FREE interactive online training resources, educational materials and tracking tools. These materials allow welding instructors to assign and deliver welding content, create quizzes, download welding labs, monitor student participation, and assess and report student progress and performance. Visit OpenBook.MillerWelds.com for details.

Customize your classroom

- Implement materials that fit your curriculum and learning objectives, including:
 - e-Learning modules
 - Weld lab activities
 - Course builder
 - Quiz builder
 - Lab builder
 - Customizable certificates of completion
- Miller® and Hobart® pre-defined courses with certificates of completion
- Track individual student progress
- All material aligns with AWS standards

Motivate and engage students

- Interactive, stimulating learning includes videos and activities
- Quick, digestible segments
- Mobile friendly
 - Easy to access homework from anywhere
 - Students can check grades and status
- Ideal for high school and post-secondary welding programs



MobileArc™ Augmented Reality Welding System See literature TS/3.0

An affordable and easy-to-use MIG welding simulation tool designed to attract, engage and introduce students to welding through a hands-on augmented reality experience.

NEW!



Only available at approved distributors!

Highly portable, lightweight design allows for easy transport for remote learning and recruiting events.

Easy setup and simple user interface allows for students to work independently, helping to increase instructor efficiency.

Real-time feedback is provided on users' technique to help correct errors, reinforce proper welding practices and accelerate skill advancement, prior to actual live arc welding in a lab.

Reduce overall training time compared to traditional methods with the realistic welding simulation of the MobileArc.

Minimize material cost by saving wire, gas and workpieces in this simulation environment, while allowing students to refine their welding skills before beginning live arc welding.

The output can be streamed to an external display for a more collaborative learning environment.

Comes complete with

- Mobile device with case
- Black Classic helmet with mobile device mount
- MIG welding gun with AR nozzle
- Mobile device gun mount
- Workpiece (configurable base plate and top plate)
- 1.50 magnifying lens
- 2.00 magnifying lens
- Mobile device charger
- Travel bag



Two interactive viewing options. **Helmet mount (view is welder exclusive) or gun mount (view can be shared).**

Stock Number	Battery Life	Process	Welding Positions	Multi-Pass	Net Weight
(907817) Only available at approved distributors	Mobile device (internal rechargeable battery): 3 hours of continuous simulation (will run indefinitely when powered through USB charging port) Welding gun (9-volt battery): 70 hours of continuous use	GMAW	2F, 1G	T-joint, butt joint, lap joint	System with travel bag: 3.2 kg (7 lb.) Welding helmet with mobile device: 709 g (25 oz.)



AugmentedArc®
Augmented Reality Welding System



LiveArc™
Welding Performance Management System



The AugmentedArc augmented reality welding system allows students and trainees to experience the most realistic multiprocess welding simulation available — and then seamlessly transition to the industry's most complete live arc experience in the LiveArc welding performance management system.

Delivering unbeatable advantages

- Optimize instructor efficiency
- Deliver real-time feedback
- Reduce overall training time
- Assess weld operator skills and performance
- Minimize material cost
- Enhance job candidate recruiting and screening
- Build a larger, more-skilled welding workforce

AugmentedArc® Augmented Reality Weld Training

See literature TS/2.0

IMPROVED!

Now includes NCCER Welding Levels 1–2 curriculum.

Available at approved locations!



Lightweight, balanced AR welding helmet with large viewing area provides a realistic augmented reality environment.

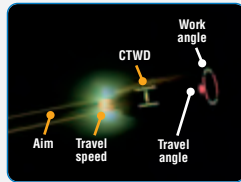
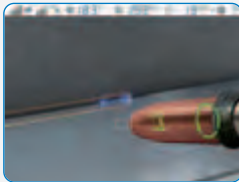

The highly realistic multiprocess welding simulation solution for classroom training.

Optimize instructor efficiency by using the Teacher software to create a virtual classroom with customized curriculum, quizzes and weld exercises.

Real-time feedback is provided on users' technique to help correct errors, reinforce proper welding practices and accelerate skill advancement prior to actual live arc welding in a lab.

Reduce overall training time. Compared to traditional methods, AugmentedArc significantly reduces the amount of time needed to teach students.

Minimize material cost by saving wire, gas and workpieces in this simulation environment, while allowing students to refine their welding skills before live arc welding.

Build a larger, more-skilled welding workforce when computer-savvy individuals are drawn to welding education programs that increase their success.

AugmentedArc system comes complete with

- AugmentedArc simulator
- Teachers software
- Black Infinity™ AR helmet with premium headgear
- AugmentedArc router
- MIG gun with AR nozzle
- SMAW stinger
- TIG torch with AR nozzle
- Two electrode/filler rods with AR tips
- Work stand for out-of-position applications
- Five workpieces: t-joint, butt joint, lap joint, pipe-to-plate and butt pipe

Optional components



TIG Foot Pedal Kit

- Includes TIG foot pedal, connection cable and adapter cable
- AugmentedArc Controller For multiple system connectivity
- Heavy-duty Transportation Cases Protects complete system during transportation or storage – one case holds the simulator and the other holds accessories

Stock Number	Input Power	Voltage/Amperage Selection	Welding Positions	Polarity Selection	Shielding Gas Selection	Wire Speed Selection	Base Material Selection	Workpiece Selection	Stick Electrode Selection	Diameter Selection	Simulator Dimensions	Net Weight
Available at approved locations	115 V, 15 A, 60 Hz	GMAW: 10–38 V 50–425 A FCAW: 10–38 V 50–425 A SMAW: 50–425 A GTAW: 50–425 A	1F–4F 1G–6G	DCEP DCEN AC	CO ₂ Argon O ₂ Argon CO ₂ Argon	GMAW/FCAW: 1.27–25.4 m/min. (50–1,000 ipm)	Carbon steel Stainless steel Aluminum	3.2, 6.4, 9.5 mm (1/8, 1/4, 3/8 in.)	E7018 E6010 E6013	Solid wire: 0.8, 1.0, 1.2 mm (.030, .035, .045 in.) Stick electrode: 2.5, 3.25, 4.0 mm (1/8, 3/32, 5/32 in.) Filler rod: 2.0, 2.4 mm (5/64, 3/32 in.)	H: 533 mm (21 in.) W: 238 mm (9.38 in.) D: 438 mm (17.25 in.)	Simulator: 9.4 kg (20.7 lb.) Helmet: 0.9 kg (1.97 lb.)

LiveArc™ Welding Performance Management System

See literature TS/1.0

Available at approved locations!

GMAW/FCAW/SMAW system shown.



The reality-based recruiting, screening, training, and re-qualification solution for industrial, manufacturing and educational markets.

Better and more cost effective training with faster results. Benefit from both weld simulation and the real-world experience of live arc welding with instant, valuable feedback on welding technique to quickly help build skills.

Motion-tracking technology measures the operator's adherence to preset technique parameters. Cameras track the movement of LEDs embedded in the MIG SmartGun and SMAW SmartStinger during pre-weld simulations and live welds; the system then delivers visual feedback on the operator's performance via the LiveArc system's main display.



LiveArc GMAW/FCAW system comes complete with

- Computer with Intel core i7, 128 GB SSD, fanless cooling, and HDMI port for connection to most secondary monitors (not included)
- 21.5 HD LCD touch screen monitor
- SmartGun with 4.6 m (15 ft.) cable
- Calibration tool
- Two table clamps
- Removable arm extension with C-clamp assembly for out-of-position right- and left-hand applications
- Extra Bernard® consumables

LiveArc GMAW/FCAW/SMAW system includes above plus

- SmartStinger with 3.7 m (12 ft.) cable
- 4.6 m (15 ft.) Dinse-style cable
- Router box
- Software update for SMAW applications

Stock Number	Input Power	Processes	Positions	Multi-Pass	Rated Output	Electrode Diameter	Dimensions	Net Weight
(907714) GMAW/FCAW system (907714001) GMAW/FCAW/SMAW system	120 V, 60 Hz Compatible with Miller power sources	GMAW, GMAW-S, GMAW-P, FCAW-G SMAW	2F–4F, 1G–4G 2F–4F, 1G–4G	Groove and fillet up to 25 mm (1 in.) plate Limited groove applications	SmartGun: 400 A at 60% duty cycle (mixed gases) SmartStinger: 250 A at 60% duty cycle	SmartGun: Up to 2.0 mm (5/64 in.) SmartStinger: Up to 3.2 mm (1/8 in.)	H: 1,969 mm (77.5 in.) W: 1,168 mm (46 in.) D: 787 mm (31 in.)	GMAW/FCAW system: 218 kg (480 lb.) GMAW/FCAW/SMAW system: 239 kg (527 lb.)

Automated MIG 99

Cable Connectors and Adapters 99/106

Carts, Cylinder Racks and Running Gear 99-101

Coolant Systems 100

Engine Drive Accessories 101-102

- Big Blue Accessories ▪ Blue Star Accessories
- Bobcat and Trailblazer Accessories
- Generator Accessories ▪ Protective Covers ▪ Trailers

Load Banks 102

MIG Accessories 102

- Machine and Gun Accessory Kits ▪ Protective Covers

Plasma Cutter Accessories 103

- Automation Kits ▪ Cables and Cable Covers
- Cutting Guides ▪ Filters ▪ Plugs and Cords
- Protective Case ▪ Torches

Polarity Switches/Controls 104

Remote Controls and Wireless Remote Controls 104-106

Stick Accessory Kits 104

Submerged Arc Accessories 104

- Cables ▪ Torch Accessories
- Wire Drive Assembly Accessories

TIG Accessories 105-106

- Kits ▪ Protective Case/Covers ▪ Remote Controls
- Torch and Weld Cable Connectors

Wire Feeder Accessories 107

- Extension Cables (14-pin) ▪ Power Supply Adapter
- Spool Adapter ▪ Spool Gun Controls and Kits
- Turntable Assembly ▪ Wire Straightener

Automated MIG

For adapters and drive motors, visit MillerWelds.com.

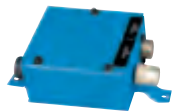

Coolant Flow Switch 195461

For water-cooled guns. To ensure coolant is flowing in the system. A lack of coolant flow may cause damage to water-cooled guns.

Module allows wiring into the peripheral connector port. 15.2 m (50 ft.) cable with connector and separate shell connector for simple modification to desired length in the field. Quarter-turn quick connection.

Cable Connectors and Adapters

Also see *Torch and Weld Cable Connectors in TIG Accessories*.

For Alumafeed system, Invision 352 MPa, XMT 350, CST, Maxstar, Dynasty and Syncrowave. These power sources are equipped with Dinse- or Tweco-style connectors for secondary connections. Power sources are shipped with two male plugs for use with #4 to #1/0 AWG cable.

Dinse-Style Connector Kits

042418 Accepts #4 to #1/0 AWG cable

042533 Accepts #1/0 to #2/0 AWG cable

Kits include one male Dinse-style plug which attaches to the work and/or weld cables and plugs into the Dinse-style receptacles on the power source.

Extension Kit for Dinse-Style Cable Connectors

042419 Accepts #4 to #1/0 AWG cable

Used to adapt or extend weld and/or work cables. Kit includes one male Dinse-style plug and one in-line female Dinse-style receptacle.

Extensions for Dinse-Style Cable Connectors

134460 Male Dinse-style plug

136600 Female Dinse-style receptacle

Used to adapt or extend weld and/or work cables. Accepts #1/0 to #2/0 AWG cable.



Tweco-Style Connector 191981

Accepts #1/0 to #2/0 AWG

cable. Kit includes one Tweco-style male plug which attaches to the work and/or weld cables and plugs into the Tweco-style receptacles on the power source.



Dinse/Tweco® Adapter 042465

Dinse/Cam-Lok Adapter 042466

One-piece adapter with Dinse-style male plug (to power source) on one end and Tweco or Cam-Lok female receptacle (for weld cable connection) on other end.



Tweco®/Dinse Adapter 210061

One-piece adapter with Tweco-style male plug (to power source) on one end and Dinse-style female receptacle (for weld cable connection) on other end.

Carts, Cylinder Racks and Running Gear



Feeder Cart 142382

A low-profile, creeper cart which allows the operator to easily move the feeder around the work area.



Universal Cart and Cylinder Rack 042934

For Invision 352 MPa, XMT 350, CST, Diversion, Maxstar 210/280 and Dynasty 210/280.

Also accommodates a single gas cylinder up to 1,422 mm (56 in.) high

measuring 152 to 229 mm (6 to 9 in.) in diameter. Provides storage for auxiliary items such as electrodes, helmets and gloves.



Running Gear/Cylinder Rack 301239

For Millermatic 141/211, Multimatic 200/215 and Diversion. Heavy-duty construction with 203 mm (8 in.) rubber rear wheels, convenient front handles, cable holders and plastic consumable box. For gas

cylinders no greater than 178 mm (7 in.) in diameter or 29.5 kg (65 lb.) in weight.



Dual Cylinder Rack Cart

Dual Cylinder Rack Conversion Kit and Tool Holder (**301454**) for use with Running Gear/Cylinder Rack above.



Dual EZ-Change™ Low Cylinder Rack with Elevated Gun and Cable Rack 300337

For Millermatic 212 Auto-Set/252 and Syncrowave 210. Allows operators to easily roll cylinders on and off the rack with no lifting and keeps cables off the floor and tangle free. Elevated Gun

and Cable Rack (**300335**) is also available separately for use with factory-installed single-cylinder rack.



EZ-Latch™ Single Cylinder Running Gear 301449

For Millermatic 255 and Multimatic 255. Running gear with a single-cylinder rack and storage compartment. Machine is secured to cart by latches that rotate to disengage machine for easy portability.



EZ-Latch™ Dual Cylinder Rack Running Gear

EZ-Latch Dual Cylinder Rack with Elevated Gun and Cable Rack (**301481**) for use with EZ-Latch Single Cylinder Running Gear above.



Dual Cylinder Rack 195299

For Millermatic 350P/350P Aluminum. Replaces single-cylinder rack.

●●● Accessories



MIGRunner™ Cart 195445
For AlumaFeed system or Invision and XMT with single-wire feeders. Small footprint and easily maneuverable, with a dual-cylinder rack low enough that you do not have to lift bottles. Durable, heavy-duty ergonomic handles are designed for comfort.



Deltaweld 350/500 Running Gear 301523
For Deltaweld 350/500. Features small footprint, dual-cylinder rack, chains for gas cylinders, ergonomic handle design and lockable front casters with two torch holders, and storage area below.



2-Wheel Trolley Cart 300971
For Maxstar 210/280 and Dynasty 210/280 with or without Coolmate 1.3. Easy-to-maneuver two-wheel cart features single-cylinder rack, chain for cylinder, straps (quick and easy to detach and carry machine), cable holders, torch holder, storage area, and filler rod storage area.



Running Gear Cylinder Rack 300408
For Invision, Dimension 650, and XMT with single- or dual-wire feeders. Holds two large gas cylinders and has gun cable hangers and a consumable drawer in front. A convenient handle allows the cart to be pulled easily through doorways. Power source and single- or dual-wire feeders can be mounted to cart and secured.



Continuum Running Gear/Cylinder Rack 301264
For Continuum. Small footprint and easily maneuverable, with cylinder rack low enough that you do not have to lift bottles.



Small Runner™ Cart 301318
For Maxstar 210/280 and Dynasty 210/280 with or without Coolmate 1.3. Cart features single-cylinder rack, foot pedal holder, two cable/torch holders and two TIG filler holders.



Runner™ Cart 300244
For Maxstar 400/800 and Dynasty 400/800 with or without Coolmate 3.5. Cart features single-cylinder rack, foot pedal holder, three cable/torch holders and two TIG filler holders.

Coolmate™ Coolant Systems

See literature AY/7.2



Coolant

Sold in multiples of four in 1-gallon recyclable plastic bottles. Miller® coolants contain a base of ethylene glycol and deionized water to protect against freezing to -38°C (-37° Fahrenheit) or boiling to 108°C (227° Fahrenheit).



Low-Conductivity Coolant (clear, pre-mixed) 043810

For TIG and MIG applications. NOT for use in push-pull systems or systems where aluminum is in coolant path/circuit.

Aluminum-Protecting Coolant (green, pre-mixed) 043809

Primarily used in push-pull systems where aluminum is in coolant path/circuit and high frequency is NOT used.

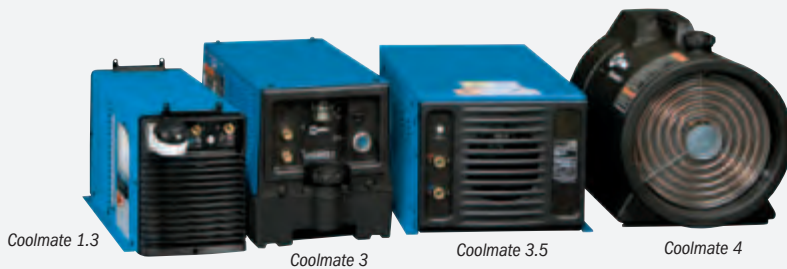

Coolmate™ 1.3 300972 120 V, CE
For Maxstar 210/280 and Dynasty 210/280. Light industrial, 4.9 L (1.3 gal.) cooler designed for water-cooled torches on power sources rated up to 280 amps*.

Coolmate™ 3 043007 120 V, CE 043008 240 V, CE
Economical, 11.4 L (3 gal.) cooler designed for water-cooled torches rated up to 500 amps*.

Coolmate™ 3.5 300245 120 V, CE
For Maxstar 400/800 and Dynasty 400/800. Industrial, 13.2 L (3.5 gal.) cooler designed for water-cooled torches rated up to 600 amps*.

Coolmate™ 4 042288 120 V
Best performer in its class – industrial, 15 L (4 gal.) cooler designed for water-cooled torches rated up to 600 amps*.

*May vary with torch design and cable length. Miller coolant systems are backed by the best warranty in the industry – one full year.

Model	Motor Input Voltage	Maximum Current Draw	Maximum Cooling Capacity	IEC Cooling Capacity	Tank Capacity	Dimensions	Net Weight
Coolmate 1.3, CE	115 V, 50/60 Hz	4.7 A (60 Hz)	3,400 W (11,600 Btu/hr.) 3.6 L/min. (3.8 qt./min.)	1,330 W (4,540 Btu/hr.) 1 L/min. (1.1 qt./min.)	4.9 L (1.3 gal.)	H: 286 mm (11.25 in.) W: 264 mm (10.38 in.) D: 610 mm (24 in.)	20 kg (43 lb.)
Coolmate 3, CE	115 V, 50/60 Hz	5.9 A (50 Hz), 4.7 A (60 Hz)	3,820 W (13,000 Btu/hr.) 4.0 L/min. (4.2 qt./min.)	1,420 W (4,840 Btu/hr.) 1 L/min. (1.1 qt./min.)	11.4 L (3 gal.)	H: 337 mm (13.25 in.) W: 311 mm (12.25 in.) D: 584 mm (23.25 in.)	18 kg (40 lb.)
	230 V, 50/60 Hz	2.5 A (50 Hz), 3.0 A (60 Hz)					
Coolmate 3.5, CE	115 V, 50/60 Hz	5.9 A (50 Hz), 4.7 A (60 Hz)	4,140 W (14,000 Btu/hr.) 4.7 L/min. (5.0 qt./min.)	1,660 W (5,660 Btu/hr.) 1 L/min. (1.1 qt./min.)	13.2 L (3.5 gal.)	H: 298 mm (11.75 in.) W: 400 mm (15.75 in.) D: 660 mm (26 in.)	29 kg (64 lb.)
Coolmate 4	115 V, 50/60 Hz	5.9 A (50 Hz), 4.7 A (60 Hz)	5,500 W (18,000 Btu/hr.) 5.6 L/min. (5.9 qt./min.)	1,780 W (6,070 Btu/hr.) 1 L/min. (1.1 qt./min.)	15 L (4 gal.)	H: 413 mm (16.25 in.) W: 387 mm (15.25 in.) D: 476 mm (18.75 in.)	17 kg (38 lb.)

Engine Drive Accessories

Also see Trailers.

Big Blue Accessories



Cable Holder 043946
For Big Blue 500 Pro/600 Series/
800 Series.



Vandalism Lockout Kit 399802 Field
For Big Blue 500 Pro/600 Series.
Lockable hinged steel panels cover
and protect name plate gauges and
ignition switch (padlock included).
Also includes engine compartment
door lock and key.

Blue Star Accessories



Lifting Eye 195353
For Fusion and Blue Star.



Running Gear 301246
For Fusion and Blue Star.
Compact and balanced, lightweight
wheelbarrow-style running gear
provides easy onsite mobility.

Bobcat and Trailblazer Accessories (Gas/LP)



Multi-Terrain Running Gear 301460
For Bobcat 200 Air Pak.
Includes two heavy-duty
Never Flat™ 381 mm (15 in.)
tires, two 203 mm (8 in.)
rubber swivel casters and a
heavy-duty handle.
Recommended for all surfaces
and applications and is easy to
move around the jobsite.



Multi-Terrain Running Gear 300913 Inner tubes
300914 Never Flat™ tires
For gas/LP Bobcat and
Trailblazer (except Air Pak
models). Includes two
heavy-duty 381 mm (15 in.)
tires, two 203 mm (8 in.)
rubber swivel casters and a
heavy-duty handle. Recommended for all surfaces and
applications and is easy to move around the jobsite.



Off-Road Running Gear 300909 Inner tubes
300910 Never Flat™ tires
For gas/LP Bobcat and
Trailblazer (except Air Pak
models). Includes four
heavy-duty 381 mm (15 in.)
tires and a rugged handle to
provide maximum
maneuverability.



Off-Road Running Gear with Protective Cage and Never Flat™ Tires 300912
For gas/LP Bobcat and
Trailblazer (except Air Pak
models). Running gear
and rugged cage with cable
holders protects your
investment and is easy to
move around the jobsite.



Protective Cage with Cable Holders 300921 For gas/LP Bobcat
and Trailblazer
(except Air Pak
models).
300473 For Trailblazer
302 Air Pak.

Rugged cage with cable holders protects your investment.
Works with Running Gear, Gas Cylinder Mounting Assembly
or LP Tank Mounting Assembly.



Gas Cylinder Mounting Assembly 300918
For gas Bobcat and
Trailblazer (except Air Pak
models). Designed for
use with Running Gear,
Protective Cage, or by itself.
Includes base tray with bottle
bracket, vertical support rack
and safety chain.

Note: Not for use with LP Tank Mounting Assembly.
Not recommended for use with Protective Cover.



Hose and LP Tank Mounting Assembly 300917 For LP Bobcat and
Trailblazer. Designed for use
with Running Gear, Protective
Cage, or by itself. Includes
bracket and clamp to mount
15 and 19.5 kg (33 and 43 lb.)
tanks horizontally, and hose
with fittings to converter.

Note: Cannot be used with Gas Cylinder Mounting Assembly.
Not recommended for use with Protective Cover.



Remote Oil Drain and Filter Kit 300923 Field
For gas Bobcat and Trailblazer (except Air Pak models).
Front mount for Kohler engines makes servicing easy when
engine drive is mounted in tight spots.

Bobcat and Trailblazer Accessories (Diesel)



All-Purpose Running Gear with Never Flat™ Tires 300477
For diesel Bobcat 250 and
Trailblazer 325. Includes two
heavy-duty 381 mm (15 in.)
tires, two 203 mm (8 in.)
rubber swivel casters and a
heavy-duty handle.

Recommended for all surfaces and applications and is easy
to move around the jobsite.



Protective Cage with Cable Holders 195331
For diesel Bobcat 250 and
Trailblazer 325. Rugged
cage with cable holders
protects your investment.
Works with Running Gear,
or with trailer. Note: Not for use with Protective Cover.

Generator Accessories

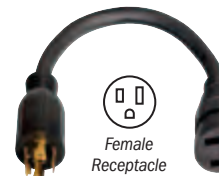

Twist Lock Adapter Cord 301489
For Fusion. L14-30R to
NEMA 6-50R. Adapts
engine drive 120/240-volt
twist lock plug to common
Millermatic and Spectrum
240-volt plug.



Female Receptacle



Full KVA Adapter Cord 300517
For Bobcat, Trailblazer and Big Blue models. NEMA 14-50P
to NEMA 6-50R. Adapts engine drive 120/240-volt plug
to common Millermatic and Spectrum 240-volt plug.



Female Receptacle

Full KVA Plug Kit 119172

1-phase, 120/240 V,
50 A plug (NEMA 14-50P). For Bobcat,
Trailblazer and Big Blue models.

165963 3-phase, 480 V, 30 A plug
(NEMA L16-30P). For Bobcat 3 Phase.

254140 3-phase, 240 V, 50 A plug
(NEMA 15-50P). For Big Blue 500 Pro/
600 Series/800 Series.

Protective Covers



Protective covers (300919) and (195301) shown.

Protective Covers

Heavy-duty, water- and mildew-resistant covers protect
and maintain the finish of the welder.

301245 For Fusion and Blue Star.

301475 For gas Bobcat 200 Air Pak **without** Running Gear.

301476 For gas Bobcat 200 Air Pak **with** Running Gear.

301531 For diesel Bobcat 200 Air Pak
without Running Gear.

301532 For diesel Bobcat 200 Air Pak **with** Running Gear.

300919 For gas Bobcat and Trailblazer (except Air Paks)
without Protective Cage or Running Gear.

300920 For gas Bobcat and Trailblazer (except Air Paks)
with Protective Cage or Running Gear.

301099 For diesel Bobcat 250 and Trailblazer 325
without Protective Cage or Running Gear.

300379 For Trailblazer 302 Air Pak.

195301 For Big Blue 400 Pro/400 PipePro/450 Duo CST.

301495 For Big Blue 500 Pro/600 Pro with Kubota.

301113 For Big Blue 600 Air Pak/800 Series with Deutz.

Trailers

See literature AY/20.0



HWY-Mid Frame Trailer 301438

For Bobcat, Trailblazer, and Big Blue 400 Pro/400 PipePro/450 Duo CST models. A 646 kg (1,424 lb.) capacity highway trailer with welded steel tubing frame, heavy-duty axle with roller bearing hubs and leaf-spring suspension. Includes jack stand, fenders, lights, and dual hitch with 50 mm (2 in.) ball hitch and 76 mm (3 in.) lunette eye.

HWY-225 Trailer 301338

For Big Blue models. A 1,225 kg (2,700 lb.) capacity highway trailer with welded steel tubing frame, heavy-duty axle with roller bearing hubs and leaf-spring suspension. Includes jack stand, fenders, lights, and dual hitch with 50 mm (2 in.) ball hitch and 76 mm (3 in.) lunette eye.

4 West Four-Wheel Steerable Off-Road Trailer 042801

For Big Blue 500 Pro/600 Series/800 Series. A heavy-duty 1,157 kg (2,550 lb.) capacity trailer designed for use in mines, quarries and other rough terrain. Has narrow 6.7 m (22 ft.) turning radius. Includes 76 mm (3 in.) lunette eye, universal hitch and safety chains.

Note: Trailers are shipped unassembled. *Width at outside of fenders. **Does not include tongue.

Trailer accessories

Fender Kit 301439

For HWY-Mid Frame and HWY-225. Replacement fenders.

Dual Hitch 301441

For HWY-Mid Frame and HWY-225. Combination 50 mm (2 in.) ball hitch and 76 mm (3 in.) lunette eye in one reversible assembly.



Cable Tree 043826

For HWY-Mid Frame and HWY-225. Provides an area to conveniently wrap weld cables and extension cords.



2-In-1 Document/Fire Extinguisher Holder 301236

For HWY-Mid Frame and HWY-225. Stores documents and holds a 2.3 kg (5 lb.) fire extinguisher.

Note: Holder shown mounted on trailer. Fire extinguisher not included.



Model	Gross Axle Weight Rating	Gross Vehicle Weight Rating	Net Payload	Height of Bed	Road Clearance	Track (Center to Center of tires)	Standard Tires (Standard Rating or P-size Rating)	Dimensions	Net Weight
HWY-Mid Frame	728 kg (1,605 lb.)	646 kg (1,424 lb.)	646 kg (1,424 lb.)	495 mm (19.5 in.)	203 mm (8 in.)	1,168 mm (46 in.)	ST175/80D-13 Load Range C	L: 2,565 mm (101 in.) W: 1,397 mm (55 in.)*	82 kg (181 lb.)
HWY-225	1,588 kg (3,500 lb.)	1,360 kg (2,999 lb.)	1,225 kg (2,700 lb.)	483 mm (19 in.)	191 mm (7.5 in.)	1,270 mm (50 in.)	ST175/80R-13 Load Range D	L: 2,680 mm (105.5 in.) W: 1,435 mm (56.5 in.)*	127 kg (280 lb.)
4 West	907 kg/axle (2,000 lb./axle)	1,361 kg (3,000 lb.)	1,157 kg (2,550 lb.)	540 mm (21.25 in.)	203 mm (8 in.)	1,403 mm (55.25 in.)	B78-13	L: 2,311 mm (91 in.)** W: 1,556 mm (61.25 in.)	191 kg (420 lb.)

Load Banks



LBP-350 043329

Designed to provide an adjustable load for troubleshooting or calibrating welding power sources or generators. Standard equipment

includes analog meters for both AC and DC output with jacks for external metering connections. It comes with a 4 m (13 ft.) 115-volt power cord and has seven 50-amp load switches, providing a maximum capacity of 350 amps.



Welding Power Load Bank 902804

Designed to load test the output of transformer-type, engine- or motor-driven generator welding power sources. This unit can be used to test AC or DC welder outputs, and to demonstrate welding equipment to customers.

MIG Accessories

Machine and Gun Accessory Kits



MIG kit with Dinse-style connectors for single-wire feeders shown.

Industrial MIG 4/0 Kit (with lugs)

300390 For single-wire feeders.

300957 For dual-wire feeders.

Consists of flowmeter regulator with 3 m (10 ft.) gas hose, 3 m (10 ft.) 4/0 feeder weld cable with lugs, and 4.6 m (15 ft.) work cable with 600-amp C-clamp. Dual kit comes with two flowmeter regulators and gas hoses.

Industrial MIG 4/0 Kit (with Dinse-style connectors)

300405 For single-wire feeders.

300956 For dual-wire feeders.

Same as above except weld and work cables have Dinse-style connector on one end instead of lug.

MIGmatic™ M-Series Gun Consumable Kits

234607 0.6 m (.023 in.) wire

234608 0.8 m (.030 in.) wire

234609 0.9 m (.035 in.) wire

For M-100/M-150 guns. Kits include ten contact tips, one tip adapter, one standard nozzle and a consumable storage box.

Protective Covers



301262

For Millermatic 141/211 and Multimatic 215.



301524

For Multimatic 220 AC/DC.



301521

For Millermatic 255 and Multimatic 255. Features side pocket.



195142

For Millermatic 212 Auto-Set/252/350P/350P Aluminum and Syncrowave 210. Features side pocket.

Plasma Cutter Accessories

Automation Kits



Spectrum 875 Auto-Line automation kit shown.

Automation Kits for Spectrum 875 and 875 Auto-Line 301156 For Spectrum 875.

301157 For Spectrum 875 Auto-Line.

Upgrades hand-held torch packages to add machine torch capabilities. Automation kit for Spectrum 875 Auto-Line (**301157**) includes a remote pendant control for manual on/off. Machine torches are NOT included in kits and must be ordered separately.

Cables and Cable Covers



Flexible Work Cable

234838 6.1 m (20 ft.)

234930 15.2 m (50 ft.)

Work cable with quick connect and heavy-duty clamp.



Cable Covers

239642 6.1 m (20 ft.)

231867 7.6 m (25 ft.)

231868 15.2 m (50 ft.)

Cutting Guides

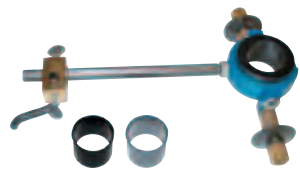

Plasma Circle-Cutting Guides 253055

For XT30/XT40/XT60 torches. Cut straight lines or circles up to 305 mm (12 in.) in diameter.



Suction/Magnetic Pivot Base 195979

Add this to your cutting guide for convenient attachment to all flat surfaces. The extended arm accommodates holes up to 762 mm (30 in.) in diameter.



Plasma Standoff Roller Guide 253054

Helps maintain recommended standoff distance to maximize cutting performance and improve tip life.

Filters



In-Line Air Filter Kit 228926

For Spectrum 375 X-TREME/625 X-TREME/875/875 Auto-Line. Mounts to back of the plasma cutter. Includes male and female 6.4 mm (1/4 in.) NPT quick-disconnect fittings and hose for easy on/off connection. The replaceable filter element (**228928**) filters to .85 microns for removal of 99.9 percent of water, dirt and oil.



RTI Filter and Bracket 300491

For Spectrum 875/875 Auto-Line. Dryer will remove water, dirt and oil as small as one micron with 99.9 percent efficiency. Can be mounted on plasma cutter or on wall. Install as close as possible to point of air consumption. Replaceable filter element (**212771**).

Plugs and Cords

MVP™ Plugs



219258

For 6-50P power cable (230/240 V, 50 A).



219261

For 5-15P power cable (115/120 V, 15 A).



219259

For 5-20P power cable (115/120 V, 20 A).

For Spectrum 375 X-TREME, Millermatic 211, Multimatic 200/215/220 AC/DC, Thunderbolt 160, Diversion, Syncrowave 210 and Fusion. Allows connection of machine to 115/120-volt or 230/240-volt receptacles without tools – just choose the plug that fits the receptacle.

MVP™ Adapters



Female Receptacle



254328

For connection to 6-50P receptacle (240 V, 50 A).



254330

For connection to 5-15P receptacle (120 V, 15 A).



254331

For connection to 5-20P receptacle (120 V, 20 A).

For Spectrum 625 X-TREME. Allows connection of machine to 120- or 240-volt receptacles without tools – just choose the adapter cord that fits the receptacle.



Female Receptacle

Full KVA Adapter Cord 300517

NEMA 14-50P to NEMA 6-50R. Adapts engine drive 120/240-volt plug to common Millermatic and Spectrum 240-volt plug.

230-Volt Extension Cord 770644

6.1 m (20 ft.) NEMA 6-50P to NEMA 6-50R heavy-duty extension cord. 8-gauge cord has lighted ends that show power is on and a molded integrated strain relief.

Protective Case



X-CASE 300184

For Spectrum 375 X-TREME/625 X-TREME.

Torches

See your Miller® distributor for complete information on the following XT plasma torches and their consumables:



Spectrum Plasma Cutter Hand-Held Torches

For Spectrum 375 X-TREME

249949 3.7 m (12 ft.) XT30

For Spectrum 625 X-TREME

260633 3.7 m (12 ft.) XT40

260635 6.1 m (20 ft.) XT40

For Spectrum 875 and 875 Auto-Line

249953 6.1 m (20 ft.) XT60

249954 15.2 m (50 ft.) XT60

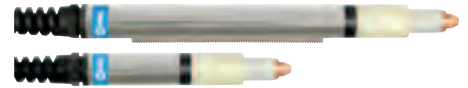

Spectrum 875 and 875 Auto-Line Plasma Cutter Machine Torches

249955 7.6 m (25 ft.) long body XT60M

249956 15.2 m (50 ft.) long body XT60M

257464 7.6 m (25 ft.) short body XT60M

263952 15.2 m (50 ft.) short body XT60M



Each consumable kit includes a storage box.

Plasma Torch Consumable Kits

253520 For XT30 torch. Includes five electrodes, five tips, one swirl ring, one retaining cup, one o-ring and silicone grease.

253521 For XT40 torch. Includes five electrodes, five 40-amp tips, three 30-amp tips, one 40-amp drag shield, two 30-amp drag shields, one deflector, one o-ring, one swirl ring, one retaining cup, one 40-amp gouge tip, one gouge shield and silicone grease.

256033 For XT60 torch. Includes three standard electrodes, three standard tips, one drag shield, one deflector, one o-ring, one swirl ring, one retaining cup, one gouge tip, one gouge shield and silicone grease.

127493 Empty consumable storage box.

Polarity Switches/Controls

Polarity Control 042871

This dual-function control is designed for use with dual wire feeders or any application where electrical isolation and/or polarity reversing of weld current is required. Both functions can be used at the same time.



Process Selector Control 042872

For CC, CV or CC/CV welding power source. Provides easy way to change welding process. Also includes features of Polarity Control.

Remote Controls

Also see Remote Controls in TIG Accessories.



PRHC-14 Hand Control 195511

For all solid-state power sources after serial number JK674521. Complete current or voltage control brings 120 volts of GFCI power to work area in a single cord. Housed in a durable and light aluminum case and includes 38 m (125 ft.) cord with plugs.

Stick Accessory Kits



No. 2 Stick Cable Sets

195196 15 ft. (4.6 m)

300836 50 ft. (15 m)

Consists of either 4.6 or 15.2 m electrode cable with holder and work cable with clamp. 200 A, 100% duty cycle.



2/0 Stick Cable Sets

173851 15.2 m (50 ft.), 350 A

043952 30/15 m (100/50 ft.), 300 A

Consists of either 15.2 or 30 m 2/0 electrode cable with holder and 5.2 m work cable with clamp. 100% duty cycle.



Weld Cables

195457 2/0 cable with electrode holder, 400 A

195458 2/0 cable with work clamp, 400 A

301387 1/0 cable with electrode holder, 250 A

Consists of a stud/Tweco® adapter and 3 m (10 ft.) weld cable with a Tweco male connector and either an electrode holder or work clamp.



2/0 Weld Cable Extensions

195456 15.2 m (50 ft.)

195455 30 m (100 ft.)

Extends weld cables

(**195457**, **195458** and **301387**).

Submerged Arc Accessories

Cables



SubArc Control Cables

260622030 9.1 m (30 ft.)

260622050 15 m (50 ft.)

260622060 18.3 m (60 ft.)

260622080 24.4 m (80 ft.)

260622100 30.5 m (100 ft.)

260622120 36.6 m (120 ft.)

260622200 61.0 m (200 ft.)

Cable between SubArc Interface or Motor Control and power source.



Flux Hopper Extension Cables

260623010 3 m (10 ft.)

260623025 7.6 m (25 ft.)

260623065 19.8 m (65 ft.)

Cable between SubArc Interface or Motor Control and flux hopper.



Motor Extension Cables

254232005 1.5 m (5 ft.)

254232010 3 m (10 ft.)

254232025 7.6 m (25 ft.)

254232065 19.8 m (65 ft.)

Cable between SubArc Interface or Motor Control and drive motor.



Continuum Motor/Control Cables

263368015 4.6 m (15 ft.)

263368025 7.6 m (25 ft.)

263368050 15.2 m (50 ft.)

263368080 24.4 m (80 ft.)

263368100 30.5 m (100 ft.)

Cable between SubArc Motor Control and SubArc Remote Pendant.



SubArc Parallel Cable

260775015 4.6 m (15 ft.)



SubArc Tandem Cable

260878015 4.6 m (15 ft.)

Torch Accessories

OBT 600 Torch Body Extensions

043967 25.4 mm (1 inch)

043969 50.8 mm (2 inch)

043973 101.6 mm (4 inch)

043975 152.4 mm (6 inch)

OBT 1200 Torch Body Extension 043981

Overall length with extension is 228.6 mm (9 inches).

Actual length of extension is 215.9 mm (8.5 inches).

OBT Torch Contact Tips

OBT 600	OBT 1200	Wire Size
192700	192141	1.6 mm (1/16 in.)
192701	199026	2.0 mm (5/64 in.)
192702	192142	2.4 mm (3/32 in.)
192703	200771	2.8 mm (7/64 in.)
192704	192143	3.2 mm (1/8 in.)
192705	192144	4.0 mm (5/32 in.)

1200-Amp Twin-Wire Torch Contact Tips

264595 1.2 mm (3/64 in.)

264596 1.6 mm (1/16 in.)

264597 2.0 mm (5/64 in.)

264588 2.4 mm (3/32 in.)

Wire Drive Assembly Accessories

Drive Rolls

132955 1.6 mm (1/16 in.)

132960 2.0 mm (5/64 in.)

132961 2.4 mm (3/32 in.)

132962 2.8 mm (7/64 in.)

132963 3.2 mm (1/8 in.)

193700 4.0 mm (5/32 in.)



Single-Wire Straightener 199733

For OBT 600 and OBT 1200 single-wire torches. For 1.6–4.8 mm (1/16–3/16 inch) wire.



Twin-Wire Straightener 301160

For 1200-amp twin-wire torch only. Single adjustment.

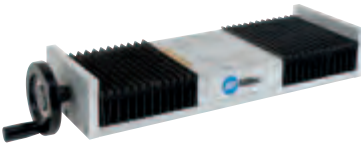

Manual Single Slide 301137

Provides smooth and accurate movement of the welding heads. Allows for 200 mm (7.87 inch) travel adjustment with load capacity of 100 kg (220 pounds) at 500 mm (1.64 feet). **Not recommended for tandem.**



Wire Reel 108008

Supports 27 kg (60 lb.) coil of wire. Requires Spool Support Assembly (**119438**).

TIG Accessories

Kits



A-200 torch with RCCS-14 kit shown.

Contractor Kit

301309 A-150 torch with RFCS-14 HD foot pedal
301311 A-150 torch with RCCS-14 fingertip
301549 A-200 torch with RFCS-14 HD foot pedal
301550 A-200 torch with RCCS-14 fingertip
 For Maxstar 210/280 and Dynasty 210/280. All-in-one TIG/stick welding kit comes with either a Weldcraft™ A-150 OR or A-200 TIG torch, RFCS-14 HD foot control OR RCCS-14 fingertip control, 200-amp stick electrode holder and 300-amp work clamp with 4.6 m (15 ft.) cables, flow gauge regulator with 3.7 m (12 ft.) gas hose, gas hose coupler, AK2C torch accessory kit, and TIG torch connector.



Multimatic 215 contractor kit shown.

RFCS-6M foot control (Multimatic 200 kit) OR RFCS-RJ45 foot control (Multimatic 215 kit), flow gauge regulator with 3.7 m (12 ft.) gas hose, and AK2C torch accessory kit.



10-pin to 14-pin adapter cord, flow gauge regulator with 1.5 m (5 ft.) gas hose, and AK1C torch accessory kit.



W-280 torch kit shown.

Weldcraft™ Water-Cooled Torch Kits

300185 250 A, W-250 (WP-20)
300990 280 A, W-280 (WP-280)
301268 375 A, W-375
300186 400 A, W-400 (WP-18SC)
 For Maxstar (except 161 models), Dynasty, and Syncrowave 300. Kit comes with 7.6 m (25 ft.) TIG torch with Dinse-style connector (thread-lock on 400-amp kit), torch cable cover, work clamp with 4.6 m (15 ft.) cable [3.7 m (12 ft.) cable on 400-amp kit], flowmeter regulator with gas hose, and torch accessory kit.

TIG Contractor Kit 301287

For Multimatic 200.

301337

For Multimatic 215.

Kit comes with Weldcraft™ A-150 TIG torch with Dinse-style connector, either a

Multimatic 255 TIG Kit 301518

Kit comes with 7.6 m (25 ft.) Weldcraft™ A-150 TIG torch with Dinse-style connector, RFCS-14 HD foot control,

Protective Case/Covers



X-CASE 301429
For Maxstar 161 models.

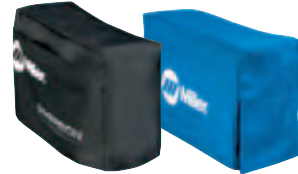

Protective covers (300579) and (301382) shown.

300579 For Diversion.

301381 For Maxstar 210.

301382 For Maxstar 280 and Dynasty 210/280.

195142 For Syncrowave 210.

Remote Controls



14-Pin to 6-Pin Adapter Cord 300507

For Maxstar 161 STL/STH and Multimatic 200. 305 mm (12 in.) cord adapts Miller®

14-pin foot control or fingertip control to a 6-pin plug.



10-Pin to 14-Pin Adapter Cord 301545

For Multimatic 255. Allows standard 14-pin

TIG remote controls to be used with the Multimatic 255.



RCC-6M (6-pin plug)

301118 4 m (13.25 ft.) cord with plug

For Maxstar 161 STL/STH and Multimatic 200.

RCC-14 (14-pin plug)

151086 8 m (26.5 ft.) cord with plug

East/west rotary-motion fingertip current/contacter control attaches to TIG torch using two hook-and-loop fasteners. Great for production or contractors that need quick ramp-up.



RCCS-6M (6-pin plug)

195184 4 m (13.25 ft.) cord with plug

195503 8 m (26.5 ft.) cord with plug

For Maxstar 161 STL/STH and Multimatic 200.

RCCS-RJ45

301146 4 m (13.25 ft.) cord with plug

For Diversion and Multimatic 215.

RCCS-14 (14-pin plug)

043688 8 m (26.5 ft.) cord with plug

North/south rotary-motion fingertip current/contacter control attaches to TIG torch using two hook-and-loop fasteners. Great for applications that require a finer amperage control.



ArcReach® Stick/TIG Remote

301325 (Tweco®) for ArcReach power sources



RFCS-RJ45 300432

For Diversion and Multimatic 215. Foot pedal current/contacter control. Includes 4.3 m (14 ft.) cord with plug.



RFCS-6M HD (6-pin plug)

195183 4 m (13.25 ft.) cord with plug

195504 6.1 m (20 ft.) cord with plug

For Maxstar 161 STL/STH and Multimatic 200.

RFCS-14 HD (14-pin plug)

194744 6.1 m (20 ft.) cord with plug

Heavy-duty foot pedal current/contacter control provides increased stability and durability from larger base and heavier cord. Reconfigurable cord can exit front, back or either side of the pedal for flexibility.



RHC-14 (14-pin plug)

242211020 6.1 m (20 ft.) cord with plug

242211100 30.5 m (100 ft.) cord with plug

Miniature hand current/contacter control.

Dimensions: 102 x 102 x 82 mm (4 x 4 x 3.25 inches).



RMLS-14 (14-pin plug) **129337**

Momentary- and maintained-contact rocker switch for contacter control. Push forward for maintained contact and backward for momentary contact. Includes 8 m (26.5 ft.) cord with plug.



RMS-6M (6-pin plug) **195269**

For Maxstar 161 STL/STH.

RMS-14 (14-pin plug) **187208**

Momentary-contact switch for contacter control. Rubber-covered pushbutton dome switch ideal for repetitive on-off applications. Includes 8 m (26.5 ft.) cord with plug.



RPBS-14 (14-pin plug) **300666**

Attaches to the TIG torch to remotely start and stop the TIG welding process. Includes 7.6 m (25 ft.) cord with plug.

Wireless Remote Foot and Hand Controls

See literature AY/6.5 (Foot) and AY/6.6 (Hand)

Increases productivity, saves money, improves safety and is easy to use.



Wireless 14-pin receiver (included with both systems)

Wireless foot control

Wireless hand control

Bluetooth® communication technology provides consistent and reliable connection, allowing precise control of the amperage.

Improves productivity and maneuverability by eliminating cord tangles. Reduces clean up time and work area cord clutter.

Improves reliability and safety by eliminating control cord failures and reducing potential trip hazard.

Multiple frequency sharing allows up to 20 systems to operate in a 27.4 m (90 ft.) radius with accuracy and precision – and without delay, system interference, or crosstalk.

Easy-to-install receiver plugs directly into the 14-pin receptacle of Miller® machines.

Easily programmable. Control can be quickly and easily paired with any other Miller® 14-pin wireless receiver. Control is preprogrammed when purchased with the receiver.

Foot control

Foot control is designed specifically for TIG welding in manufacturing, fabrication and plant applications, allowing operator to adjust amperage at point of use without the limitations of a remote cord.

Auto on feature extends the battery life up to 250 hours of welding without turning the pedal on and off.

Easy-Glide Wear Pads™ glide across concrete, making it easy to reposition the pedal for comfort and speed.

Hand control

Hand control is designed for stick, TIG, MIG and flux-cored welding, allowing operator to adjust parameters for different joint configurations, electrodes and wire types/sizes at the point of use instead of walking back to the machine.

Allows parameter adjustments up to 91 m (300 ft.) away from welder without returning to machine.

Improves weld quality. Operators can adjust their machines to optimize the parameters for different joint configurations, electrodes, and wire types and sizes.

Smart Touch™ buttons allow quick and accurate machine parameter adjustments.

Digital meter display allows presetting percentage of machine output before welding, and viewing of amperage and voltage while welding.

**Some applications are not suitable for wireless communication. Keep in mind that the rated range is subjective, and depends on factors such as obstructions, frequency interference, transmission technology, and weather. The figures listed assume ideal conditions are present.*

Model/Stock Number	Component	Power Supply	Battery Life	Rated Range*	Temperature	Radio Frequency	RF Power	Antenna	Dimensions	Weight
Wireless Foot Control System (301580), CE	Foot control (transmitter)	Three AA batteries	250 hours	27.4 m (90 ft.)	-25° to +70°C (-13° to +158°F)	2.4 Ghz (ISM band)	<3 mW	Internal	H: 152 mm (6 in.) W: 146 mm (5.75 in.) D: 292 mm (11.5 in.)	1.4 kg (3 lb.) w/batteries
Wireless Hand Control System (301582), CE	Hand control (transmitter)	Three AA batteries	250 hours	91 m (300 ft.)					H: 127 mm (5 in.) W: 70 mm (2.75 in.) D: 35 mm (1.375 in.)	0.27 kg (0.6 lb.) w/batteries

Industrial

Processes

- TIG (GTAW) ▪ Pulsed TIG (GTAW-P)
- Stick (SMAW)¹ ▪ MIG (GMAW)^{1,2}
- Flux-cored (FCAW)^{1,2}

¹With wireless hand control only.

²Only with voltage-sensing feeder.

Comes complete with

- Wireless foot control (301580) **OR** hand control (301582) transmitter
- Wireless 14-pin receiver (301584)
- Four AA batteries
- Four Easy-Glide Wear Pads™ (foot control only – sold individually, 248274)
- Carabiner clip (hand control only, 285341)

Suggested power sources



Look throughout this catalog for the icon above signifying compatibility with a wireless remote.

TIG Accessories (continued)

Torch and Weld Cable Connectors

Air-Cooled TIG (GTAW) Torch Connectors



273483^{1,2}

For *Multimatic 200/215/220* and *Maxstar 161*.

25 mm (small) Dinse-style gas thru for one-piece air-cooled torches.



194723 A-200 (WP26)

194722² All others

For *Syncrowave 210*.

50 mm Dinse-style gas thru for one-piece air-cooled torches.



195379 A-200 (WP26)

195378² All others

For *Multimatic 235/255*, *CST*, *Syncrowave 300/400*, *Maxstar 210/280/400*, and *Dynasty 210/280/400*.

50 mm Dinse-style for one-piece air-cooled torches.

Water-Cooled TIG (GTAW) Torch Connectors



50 mm Dinse-Style Flow Thru 195380

For *Syncrowave 210*. Used with all Weldcraft™ water-cooled torches.



50 mm Dinse-Style with Water Return Line 195377

For *Syncrowave 300/400*, *Maxstar 210/280/400* and *Dynasty 210/280/400*. Used with all Weldcraft™ water-cooled torches.



50 mm Thread-Lock-Style 225028

For *Maxstar/Dynasty 800*. Used with all Weldcraft™ water-cooled torches.



Thread-Lock-Style Weld Cable Connectors 225029

For *Maxstar/Dynasty 800*. Contains two male connectors that accept #1/0 to #4/0 AWG size cable.

¹Except A-200 (WP26) torches. ²A-80 (WP24) torches require **24-5** adapter.

Wire Feeder Accessories

Extension Cables (14-Pin)

8-Conductor Cables

- 242208025** 7.6 m (25 ft.)
- 242208050** 15.2 m (50 ft.)
- 242208080** 24.4 m (80 ft.)

For SuitCase 12RC feeder, 20 Series feeders, and 70 Series (except MPA Plus) feeders. For 14-pin remote controls and 24 VAC wire feeders. 14-pin plug to a 14-pin socket. Not for 115-volt XR feeders.

11-Conductor Cables

- 247831025** 7.6 m (25 ft.)
- 247831050** 15.2 m (50 ft.)
- 247831080** 24.4 m (80 ft.)

For XR-AlumaFeed and MPA Plus feeders. Eleven conductors to support contactor control and remote voltage control on all Miller® electronic constant-voltage (CV) 14-pin power sources. Additional functions supported when using the Invision MPA or XMT MPA power sources include synergic pulsed MIG, remote process select and side select capabilities.

14-Conductor Cables

- 242205025** 7.6 m (25 ft.)
- 242205050** 15.2 m (50 ft.)

For HDC and WC-115 weld controls. Fully-loaded 14-pin extension cables for remote controls, and 24-volt and 115-volt feeders.

Euro Gun Adapter

164902

Power Supply Adapter



PSA-2 Control 141604

Required when using SuitCase 12RC, 20 Series, and 70 Series feeders with power sources having only 115-volt power available. Control is equipped with a 14-pin receptacle and a 3 m (10 ft.) interconnecting cord with Hubbell connections

for older-style power sources. Can also be used with competitive power sources requiring a contact closure for contactor control.

PSA-2 Extension Cord 047813

7.6 m (25 ft.) cord extends 3 m (10 ft.) cord supplied with PSA-2 control (4-pin to 4-pin connection).

Spool Adapter

047141

For use with 6.4 kg (14 lb.) spool of Hobart or Lincoln self-shielding wire.

Spool Gun Controls and Kits

For more information see literature M/1.5, M/1.73 and M/1.76.

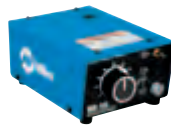

SGA 100 043856

Required to connect Spoolmate 3035 spool gun to any Millermatic 141/211. Also allows connection to virtually any similar MIG welder – Miller or other brands. Includes 3 m (10 ft.) 115-volt power cable with plug, 1.8 m (6 ft.) interconnecting cable, and 1.5 m (5 ft.) gas hose.



SGA 100C 043857

SGA with contactor required to connect Spoolmate 3035 spool gun to CV engine drives like the Miller Bobcat. Includes 3 m (10 ft.) 115-volt power cable with plug, 1.8 m (6 ft.) interconnecting cable, and 1.5 m (5 ft.) gas hose.



WC-115A Weld Control

137 546 Without contactor
137546011 With contactor
Operates on 115-volt power and designed primarily for constant-current DC power sources. Can also be used with

constant-voltage (CV) power sources or DC engine drives supplying 115 volts. Used with a constant-current (CC) source the control circuit functions in a voltage-sensing mode, and with a CV source it functions as a constant-speed circuit. Includes wire run-in and drive motor acceleration controls which ensure optimum arc starting performance.



WC-24 Weld Control 137549

For Spoolmate 200, Spoolmatic and Spoolmatic Pro. Easily mounts on power source. Designed for use with Miller® constant-voltage (CV) power sources with 14-pin receptacles and supplying 24 VAC.

Spool Gun Extension Hose and Cable Kits

- 132228** 7.6 m (25 ft.)
- 132229** 15.2 m (50 ft.)

For Spoolmate 200, Spoolmatic and Spoolmatic Pro. Extends leads, etc. between spool gun and power source.

Turntable Assembly

146236

Allows feeder to rotate as operator changes work position. Reduces strain and bending of gun cable.

Wire Straightener



For 20 Series and 70 Series.

- 141580** For 0.9–1.1 mm (.035–.045 inch) wire.
- 141581** For 1.6–3.2 mm (1/16–1/8 inch) wire.

For All Your Industrial MIG Gun and Consumable Needs

We've merged our catalogs and our websites to provide one source for all your semi-automatic, robotic, and fixed automatic MIG welding gun and consumable needs.

Visit us online today at **Tregaskiss.com** to access product information, use our online product configurators and learn how to get more out of your welding applications. While you're there you can **request a hard copy of the latest Bernard and Tregaskiss MIG Welding Guns and Consumables catalog** or **sign up for Amperage**, our electronic newsletter.



Tregaskiss.com



International Headquarters
Miller Electric Mfg. LLC
1635 West Spencer Street
Appleton, Wisconsin 54914, U.S.A.
International Dept.
FAX: 920-735-4125
E-mail:
international@millerwelds.com

ITW Welding Products Group (FZE)-UAE
Phone: +971-4-299-6621
E-mail: contact@itw-me.ae
Website:
www.weldingproductsgroup.com

ITW Welding Products – Singapore Pte. Ltd.
Phone: +65-6552-1223
E-mail: sgoffice@millerwelds.com
Website: https://sea.itw welding.com

Beijing Miller Electric Mfg. LLC
Phone: +86-10-8739-7080
E-mail: admin@millerchina.com
Website: www.millerchina.com

Welding Products Group – Latin America
Phone: 920-735-4554
E-mail:
international@millerwelds.com

ITW Welding – Brasil
Phone: +55-11-3090-3623
E-mail: contato@itw welding.com.br
Website: www.itw welding.com.br

ITW Welding SAS – France
Phone: +33-1-6004-1166
E-mail: miller@itw-welding.fr

ITW Welding Products – España
Phone: +34-96-393-5398
E-mail: vcubero@itw-welding.es
Website: www.itw-welding.es

ITW Welding Products – Mexico
Phone: +52-55-5366-7370
E-mail: ventas@itw welding.com.mx
Website: www.itw welding.com.mx

Welding Industries of Australia
Phone: +61-8-8276-6494
E-mail: info@welding.com.au
Website: www.welding.com.au

Weldwell New Zealand
Phone: +64-6-834-1600
E-mail: info@weldwell.co.nz
Website: www.weldwell.co.nz

ITW India Ltd.
Phone: +91-75-7580-4663
E-mail: fredric.prabu@millerwelds.com















ITW Welding S.R.L. – Italy
Phone: +39-02-9828-8040
E-mail: miller@itw-welding.it

ITW Welding Products – Nordic
Phone: +46-31-726-4600
E-mail: infowelding@itw-welding.se

ITW Welding Products LLC – Russia
Phone: +7-495-232-5329
E-mail: infosvarka@itw-welding.ru

Orbitalum Tools GmbH – Miller Europe
Phone: +49-7731-792400
E-mail: Sales.Miller@itw welding.com

CONTENTS

INTRO	New from Blue 3 Benefits of Blue 4
	MIG (GMAW) 6
	Wire Feeders 17
	MIG Guns 23
	Multiprocess 28
	Stick (SMAW) 42
	TIG (GTAW) 46
	Welding Intelligence™ 63
	Engine-Driven Welder/Generators 66
	Submerged Arc 79
	Induction Heating 83
	Plasma Cutters 86
	Welding Safety and Health 88
	Workstations 95
	Training Solutions 96
	Accessories 99

Index New! or Improved! products appear in blue type.

AlumaFeed Welding System10	Insight Centerpoint65	Spectrum Series86
ArcReach Heater.....85	Insight Core64	Spoolmate Spool Guns.....25
ArcReach Smart Feeder.....19	Intellx Feeders and Swingarc.....12	Spoolmatic Spool Guns.....26
ArcReach Stick/TIG Remotes.....38	Invision MPa Plus System.....13	SubArc Components.....80
ArcReach SuitCase Feeders.....19	LiveArc System.....98	SubArc Digital Series.....79
ArcStation 30FX.....95	Maxstar 161 S.....42	SubArc Portable Welding System.....82
ArcStation 60SX.....95	Maxstar 161 STL/STH47	SubArc 3-Wheel Tractor81
AugmentedArc System.....98	Maxstar 210/280 Series.....51	SuitCase 12RC Feeder19
Auto-Continuum Systems.....15	Maxstar 210 STR.....43	Syncrowave 21048
Big Blue 400X Pro.....74	Maxstar 280 Multiprocess32	Syncrowave 300/400.....50
Big Blue 450 Duo CST77	Maxstar 400/80053	20 Series Bench Feeders.....20
Big Blue 500X CC/600X CC.....76	MDX Series MIG Guns24	Thunderbolt 160/21042
Big Blue 500X Pro.....75	MIGmatic M-Series MIG Guns23	Trailblazer Series72
Big Blue 700X Duo Pro77	Millermatic 141/2116	Trailblazer 302 Air Pak.....74
Big Blue 800X Duo Air Pak78	Millermatic 2527	Trailers.....102
Blue Star 185.....66	Millermatic 255.....8	Weldcraft Series TIG Torches54
Bobcat Series70	Millermatic 355.....9	Welding Safety and Health88
Bobcat 200 Air Pak.....68	MobileArc System.....96	Apparel/Jackets94
Continuum Systems.....14	Multimatic 200.....28	Face Shields.....93
Coolmate Coolant Systems100	Multimatic 215.....28	Gloves.....93
CST 28244	Multimatic 220 AC/DC.....29	Helmets.....90
CST 282 Racks.....44	Multimatic 235.....30	Helmet Accessories.....92
Deltaweld Systems11	Multimatic 255.....31	Respiratory.....88
Dimension 650/650 ArcReach37	OpenBook.....96	Safety Glasses.....92
Diversion 18047	PipeWorx 400 Welding System.....40	Weld-Mask92
Dynasty 210/280 Series.....51	ProHeat Induction Heating.....83	Wireless Remote Controls69/106
Dynasty 280 DX Multiprocess.....32	70 Series Bench Feeders.....21	XMT 350 FieldPro Systems.....35
Dynasty 400/800.....53	70 Series Remote Configurations.....22	XMT 450 CC/CV ArcReach36
Fusion 16066	70 Series Swingarc.....22	XMT Racks.....36
		XMT Series.....33
		XR Push-Pull Guns.....27

